

INSTRUCTION MANUAL

BUILT-IN ON-DEMAND
VACUUM SYSTEM

英語
/ ENGLISH

AR 2000 S V (A)
AR 2000 M V (A)
AR 2000 H V (A)

CONTENTS

INTRODUCTION.....	1
IMPORTANT SAFETY INSTRUCTIONS.....	2
NOMENCLATURE	5
TECHNICAL DATA	6
PREPARATION BEFORE USE ...	7
OPERATING THE AIR RIVETER...8	
MAINTENANCE	9
STORAGE	15
TROUBLESHOOTING	16
AR2000SV(A) PARTS TABLE ...	17
AR2000MV(A) PARTS TABLE ...	19
AR2000HV(A) PARTS TABLE ...	21



Professional model of air riveter to install blind rivets.

- Thank you very much for purchasing “LOBSTER” air riveter. To ensure correct operation, please read this instruction manual carefully, and keep it in a safe place for later reference.
- This instruction manual contains information for models AR2000SV(A), AR2000MV(A) and AR2000HV(A). Be sure to refer to information that is applicable to the model you are using.
- This is Original instructions. (Original Instruction Manual is written in English language.)

MANUFACTURER
LOBTEX CO.,LTD.
International Marketing & Sales Division

12-8 Shijo-cho, Higashi-Osaka City
Osaka 579-8053, Japan

Telephone: +81(72)981-7466 Telefacs: +81(72)981-9420

URL <https://www.lobtex.co.jp/>

PRINTED IN JAPAN

INTRODUCTION

Thank you very much for purchasing “LOBSTER” air riveter.

- These are the blind rivet tools which is only used for fixing blind rivets. These tools are not designed for other purposes.
- This instruction manual shows how to use the tools safely, work properly, maintenance and inspection which will make tools more effectively.
- Please check the blind rivets specification and durability on customers side before using it.

1 IMPORTANT NOTICES

- Read this manual carefully before using this tool. Follow instructions in this manual for handling this tool, replacing accessories or replacing parts as needed.
- If you have any questions about this manual, contact the “LOBSTER” dealer where you purchased the tool.
- It is impossible to foresee all potential dangers and describe them in this manual. You must operate this tool paying attention to safety as well as observing the instructions in this manual.
- This manual is translated from Japanese, its original language. It is your own responsibility to achieve a full understanding of the contents of this manual before using the equipment described.
- Lobtex Co., Ltd. has the copyright of this manual. It is prohibited to publish, copy or translate to other language without prior consent.

2 INDEMNIFICATION

- Our warranty does not apply to direct and indirect damages and lost income caused by the misuse, abuse, and unauthorized modification of the tool.
We do not guarantee the strength or quality of blind rivet.
- We do not guarantee any damages and failures caused by any modifications without our written approval.
- We do not guarantee any damages and failures caused by use of parts other than our recommendation.

IMPORTANT SAFETY INSTRUCTIONS



- ◆ Be sure to read the following Important Safety Instructions carefully and make sure that you understand them thoroughly before using this tool.



- ◆ Always wear protective goggles while using the tool.
The rivets may jump out by accident and cause injuries.



- ◆ This is the safety alert symbol. It is used to alert you to potential personal injury hazards. Obey all safety messages that follow this symbol to avoid possible injury or death.

- ◆ These Important Safety Instructions are divided into **⚠ WARNING** and **⚠ CAUTION**.
The differences between these two levels are described below.

⚠ WARNING : Indicates a potentially hazardous situation which, if ignored, may result in death or serious injury to the operator.

⚠ CAUTION : Indicates a potentially hazardous situation which, if ignored, may result in moderate injury to the operator or physical damage.

Moreover, failure to follow the instructions marked with the **⚠ CAUTION** symbol or cautions without a

⚠ CAUTION symbol which appear in the text of this manual may also have serious results in some cases. Always be sure to observe the instructions given in the Important Safety Instructions.

- ◆ After reading this manual, keep it in a safe place where it is easily accessible to all users.

⚠ WARNING

- 1. The air pressure should be kept within the range of 0.5 to 0.6 MPa (71 to 85 psi).**
 - If an air pressure which is greater than this is used, the tool may become damaged, and injury or damage to property may result.
- 2. Never look into the nosepiece of the tool, and never point the nosepiece toward other persons.**
 - If the tool is used while the rivet cut mandrels are still inside the tool not being ejected, these mandrels may be ejected from the tool's nosepiece during use and cause serious injury.
- 3. Always attach the tank unit before use.**
 - If this is not observed, the mandrel may eject out when the rivets are cut and cause serious injury.
- 4. Be sure to remove the frame head when adding hydraulic oil through the cylinder.**
 - If the frame head is not removed before adding oil, excess oil may remain inside the tool, and damage to the tool or personal injury may result. (Except the case when adding hydraulic oil through the bleed plug.)
- 5. Make sure that the tool and the air source are connected securely.**
 - If the threads of the joints do not match or if the screws are not inserted far enough, the air hose may become disconnected during use and injury may result.
 - Use hose bands to securely connect the air hose joint and air hose. If they are not connected securely enough, the air hose may become disconnected during use and injury may result.
- 6. Turn off the air supply before disconnecting the tool from the air source.**
 - Compressed air may cause the air hose to whip around, and injury may result.
- 7. Check that all the tool parts are free from damage before use. Any damaged parts should be repaired before the tool is used.**
 - If the tool is used while any parts are damaged, injury may result.
 - If the tool is damaged by objects being dropped onto it, the damaged part may break and accident or injury may result.
 - Don't pull and drag the tool by the air hose. It may trigger some damages on the tool body, breakage of Rotary Joint or some other defects and lead serious troubles with injuries.
- 8. If using in elevated locations, use a safety harness, and take care to avoid dropping rivets or the tool itself.**
 - Accident or injury may result if this practice is not followed.
- 9. Wear protective glasses during use.**
 - Failure to do so may result in an accident or personal injury in case that a rivet or a piece of cut mandrels jumps out toward you.



CAUTION

1. **Before starting maintenance or disassembling the unit to replace parts, be sure to stop air supply.**
 - Performing maintenance or disassembly with air supplied may cause a part to jump out, oil to squirt out, or the unit to perform unexpected behavior, and may result in an accident or personal injury.
2. **Do not operate the tool without equipped the frame head.**
 - Items such as fingers or a hand may become caught in the mechanism.
3. **Do not bring your face close to the air outlet holes.**
 - Pressurized air containing fine particles is discharged from the air outlet holes during use. Keep eyes away from this area.
4. **Avoid skin contact with substances such as hydraulic oil, lubricating oil and grease.**
 - Such substances may cause inflammation of the skin. If they come into contact with your skin, wash the affected area thoroughly.
5. **Make sure that the workplace is safe, clean and organized.**
 - Accidents can easily occur in untidy workplaces.
 - If the cut mandrels are allowed to fall onto the floor, you may slip on them, and injury may result.
6. **Avoid uncomfortable postures while working.**
 - You may fall down and injury may result.
7. **Keep people who are not involved in work away from the workplace.**
 - Accidents or injury may result.
8. **Maintain the tool with due care.**
 - Refer to the Instruction Manual for details on replacing parts and attachments, otherwise injury may occur.
 - Keep the hand grip dry and clean, and avoid adhesion of oil and grease. Otherwise the grip may slip from your hand resulting in falling of the unit.
9. **Use the tool carefully and concentrate on correct operation at all times.**
 - Use the tool with proper care, paying full attention to methods of handling and operation and surrounding conditions. Accidents and injury may result if this practice is not followed.
 - Use common sense at all times, otherwise accidents or injury may result.
 - When you are tired, do not use the tool, otherwise accidents or injury may result.
10. **Ask Lobtex to carry out any repair work required.**
 - Repair work should only be carried out by a qualified technician. Please contact your nearest "LOBSTER" distributor, representative, or direct to Lobtex Co., Ltd., Osaka. If the tool is repaired by someone without the necessary qualifications and experience, the tool may not perform to optimum standards, and accidents or injury may result.
11. **Do not attempt to modify the tool.**
 - Unauthorized modifications may cause malfunctions which can lead to accidents or injury.
12. **Only for EU countries, do not dispose of electric tools together with household waste material !**
 - In observance of European Directive 2002/96/EC on waste electrical and electronic equipment and its implementation in accordance with national law, electric tools that have reached the end of their life must be collected separately and returned to an environmentally compatible recycling facility.
13. **The parts to be used must be those supplied from Lobtex or recommended by Lobtex. Select and attach parts applicable to your rivet.**
 - Otherwise the unit may not produce maximum performance and may sometimes malfunction resulting in an accident or personal injury.



CAUTION

14. Do not leave the floor littered with cut-mandrels.
 - Cut-mandrels are dangerous because their ends are sharp.
Stepping on them is also dangerous easily causing a slip and fall accident.
15. The production date of this product is shown brevity code below the tools. (on page 6)
16. Warning labels include important information and tips on using the machine. If the labels become so dirty or damaged that they cannot be read, order and replace them with new labels. You can order new labels from Lobtex Co., Ltd. through our dealers.
17. This product is a tool for exclusive use of the professional business. When you are the one who uses this tools for the first time, please receive an instruction from the one who have already used this tools before, also please read the Instruction Manual carefully and understand the content.
 - Wear protective goggles or safety glasses.
 - If the tool is broken, do not operate.
18. For the maintenance of the main body, for every 300,000 installation of the fastener or in one year.
19. Only persons who are well trained and qualified should use, adjust, and maintain this product.
20. Do not modify the tool. Any modification to the equipment impairs the validity of safety devices, leading to a higher risk to operators.
21. Slip, trips and falls are major causes of workplace injury. Be aware of slippery surfaces caused by use of the tool and also of trip hazards caused by the air line or hydraulic hose.
22. Proceed with care in unfamiliar surroundings. There can be hidden hazards, such as electrical or other utility cables.
23. This machine is not intended for use in potentially explosive atmospheres and is not insulated against contact with electric power.
24. Ensure that there are no electrical cables, gas pipes, etc., which can cause a hazard if damaged by use of the tool.
25. If you experience numbness, tingling, pain or whitening of the skin in your fingers or hands, stop using the tool, inform your employer and consult a physician.
26. Compressed air can cause severe injury:
 - Be sure to disconnect the tool from the air supply source when it is not in use or before replacing or repairing it.
 - Never direct air at yourself or anyone else.
27. Whipping hoses can cause severe injury.
Always make sure there are no damages on hoses and no loose fittings.
28. Do not carry the pneumatic tool by holding the hose.
29. Preventative maintenance should be carried out, after a specified time of operation, a specified number of cycles/operations or a stated number of times per year.
30. When you handle oil or grease, obtain the material safety data sheet (SDS) from the supplier, and follow the described instructions.
31. Tighten the Bleed Plug firmly before use.
 - If the Bleed Plug is loose or coming off during use, oil may squirt out resulting in an accident or personal injury.

NOMENCLATURE

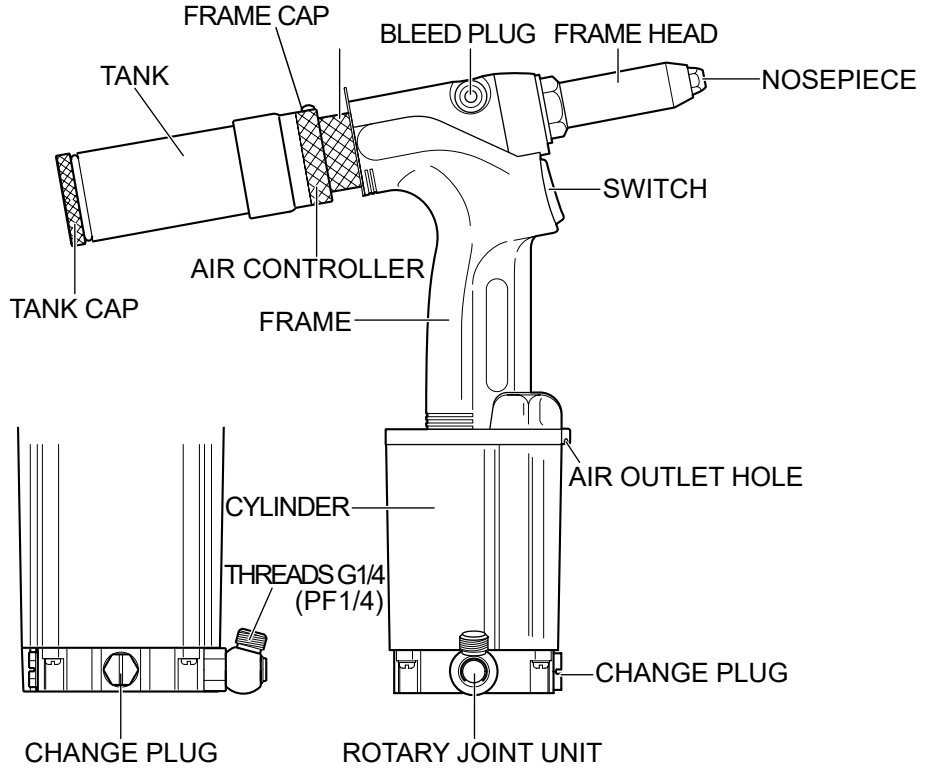

FRAME HEAD INTERNAL PARTS

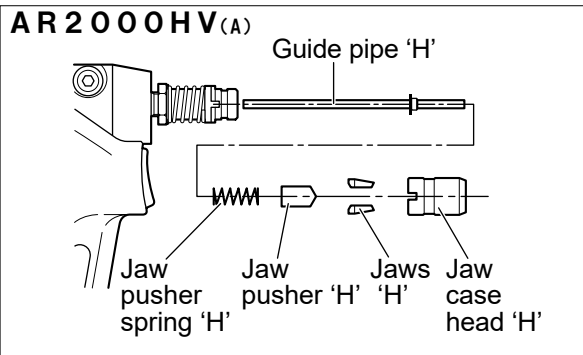
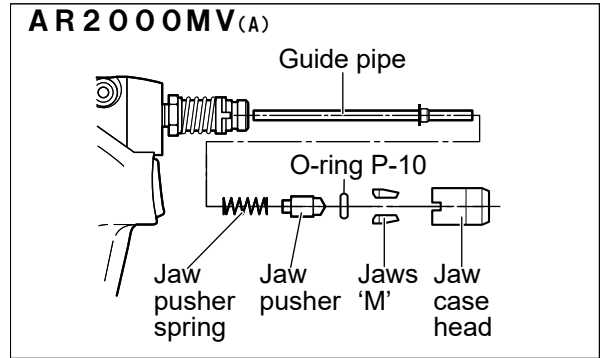
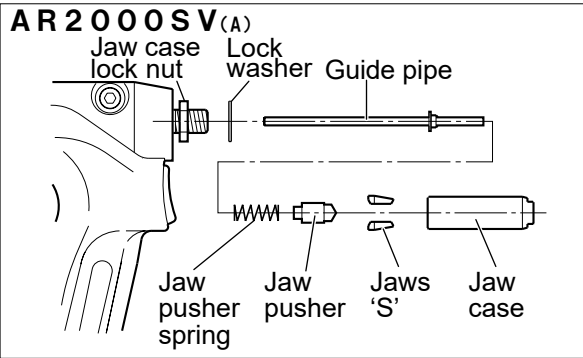

TECHNICAL DATA

Model No.		AR2000SV (A)	AR2000MV (A)	AR2000HV (A)
Weight	kg (lbs)	1.2 (2.65)	1.4 (3.09)	1.8 (3.97)
Operating air pressure		0.5 ~ 0.6 MPa (71 ~ 85 psi.)		
Dimensions (Length × Height × Width) mm		284 × 240 × 95	302 × 283 × 95	328 × 323 × 105
Air consumption per minute	ℓ (c.ft.)	90 (3.18)	90 (3.18)	120 (4.24)
Tool stroke	mm (inch)	14 (35/64)	16 (5/8)	18.5 (23/32)
Traction power at 0.6 MPa	(kN)	4.8	9.1	14.0
Applicable rivets (rivet diameters)	Φ mm Φ inch	2.4, 3.2, 4.0 *	2.4, 3.2, 4.0, 4.8 3/32, 1/8, 5/32, 3/16	4.8, 6.4 3/16, 1/4
Operating environment	Temperature	4 °C to 35 °C		
	Relative humidity	80%RH max. (no condensation)		
Sound	Pressure level (Lpa)	75 dB		
Vibration	Emission value	Less than or equal to 2.5 m/sec ²		
Air intake (Rotary joint)		Size of screw G1/4 (PF1/4)		

* 4.0 mm stainless steel rivets can not be used.

- Product specifications and design are subject to change for improvement without notice.
- Weight and dimensions given are standard values.
Actual products may differ slightly from the values given.
- AR2000HV(A) is available to install 3.2 (1/8") and 4.0 (5/32") blind rivets subject to conversion of jaw case head, ultra jaws, jaw pusher and nosepiece.
Furthermore, use the H4.8 guide pipe (yellow) which is installed in the tool as a standard accessory.

Index no.	Part name	Code no.
3	Jaw case head 'M'	14378
4	Ultra Jaws (pair) 'M'	10281
6	Jaw pusher 'H'	10224
1	Nosepiece 'M' 3.2 (1/8)	10214
1	Nosepiece 'M' 4.0 (5/32)	10215

Manufacturing year of unit	➡ Indicated on the Cylinder top unit
Installation site of rated label	➡ Along the side of Air Cylinder
Installation site of caution label	➡ Along the side of Air Cylinder

* Rated plate and caution plate is identical.

How to read the year and month of production

A year/month of manufacture	1	2	3	4	5	6	7	8	9	10	11	12
An English character	A	B	M	N	K	W	T	Y	U	O	L	Z

Example
 year: 201④ month: ⑧ → NY
 ↓ ↓
 N Y

■ Air consumption calculation method ■

Use the following calculation method to obtain the required air consumption, and select the compressor accordingly.

$$\boxed{\text{Required air consumption} = \text{Air consumption per minute}}$$

Make sure that this corresponds to the compressor discharge capacity (per minute).

PREPARATION BEFORE USE

1 Remove the dust-proof cap on the bottom of the tool, and then connect the rotary joint unit.

- ❑ Connect the end of the rotary joint unit which has the O-ring fitted to the tool.

⚠ WARNING5 (P.2)

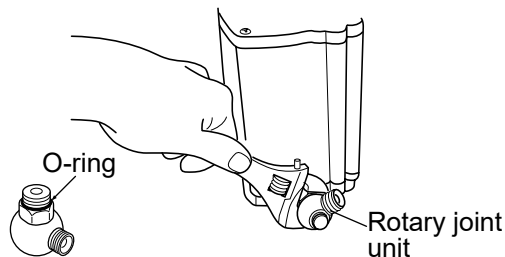

2 Install the tank unit to the tool.

- ❑ Fit the tank unit onto the air controller securely as shown in the illustration.

⚠ WARNING3 (P.2)

- ❑ Tank unit can easily be fitted onto the air controller by pushing the nosepiece against the table as shown right.

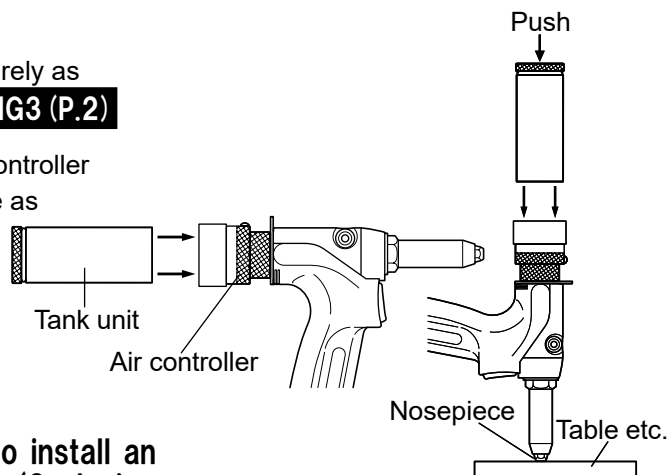

3 Set up the compressor, and be sure to install an air filter, air regulator and air lubricator (3-device set) between the compressor and the tool.

- ❑ Adjust the drip-feed amount of the air lubricator to the minimum setting.

ATTENTION:

In case of the usage in the cold district, the moisture laden air in the tool body may be frozen on the inside cylinder surface. As the result, it may not work. To dehydrate, we recommend to add the air-dryer unit to the normal three units (Regulator, Filter, and Lubricator).

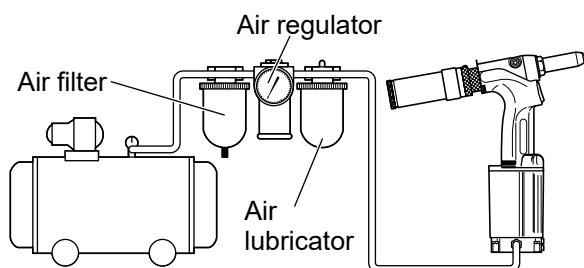

4 Use the air regulator to adjust the operating air pressure to 0.5 ~ 0.6 MPa (71 ~ 85 psi). **⚠ WARNING1 (P.2)**

- ❑ If installing stainless steel rivets with a diameter of 4.8 mm (3/16") with the AR2000MV(A), set the air pressure to 0.55 ~ 0.6 MPa (78 ~ 85 psi).

ATTENTION:

If the air pressure is too high, damage to parts may occur. If the pressure is too low, some size of the rivet may not be correctly installed (cut).

5 Replace the nosepiece and guide pipe as indicated below to conform to the size of the rivet being used.

Refer to “Jaw maintenance” on page 10 for details on replacing the guide pipe.

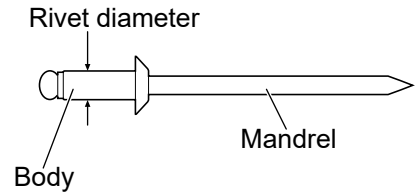

Part No.	Rivet Dia.	Nosepiece	Guide Pipe	
AR 2000SV (A)	2.4 mm (3/32")	2.4		
	3.2 mm (1/8")	3.2		
	4.0 mm (5/32")	4.0		
AR 2000MV (A)	2.4 mm (3/32")	2.4		
	3.2 mm (1/8")	3.2		
	4.0 mm (5/32")	4.0		
	4.8 mm (3/16")	4.8		
AR 2000HV (A)	4.8 mm (3/16")	4.8		
	6.4 mm (1/4")	6.4		

Shaded areas indicate parts which are installed in the tool as standard accessories.

* If using the AR2000SV(A) or AR2000MV(A), either guide pipe X or guide pipe Y can be used for 3.2 mm (1/8") diameter rivets.

⚠ CAUTION Nosepiece Selection

Conform the size to be used, and replace the nosepiece with the corresponding one. Wrong size selection of the nosepiece will cause jamming the spent mandrel inside.

OPERATING THE AIR RIVETER

1 Select a rivet of a size which is suitable for the workpiece to be riveted.

2 Replace the nosepiece with one which matches the size of the rivet to be used. (Refer to item **5** in "Preparation Before Use" on page 8.)

3 Drill a hole of appropriate size (0.1 to 0.2 mm larger than the diameter of the rivet) into the workpiece.

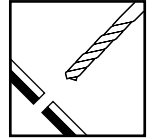

4 Turn the air controller 90 degree in the ON direction to switch on the vacuum system. Over 90 degree turn in the ON direction may cause the damage of the tool. Insert the mandrel of the rivet into the tool's nosepiece.

ATTENTION:

Some rivets have mandrels with sharp ends. Be careful not to injure your fingers on these ends.



5 After inserting the mandrel of the rivet into the nosepiece, insert the head of the rivet into the hole.

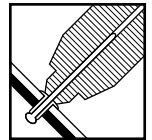

6 Gently press the nosepiece of the air riveter against the workpiece. After checking that there is no gap between the nosepiece and the workpiece, press the switch.

☐ When you pull the switch or during the keeping pull position, you may find a little air leak from the point of this switch. This is not the defective of the quality but the normal condition.

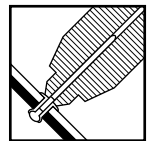

7 The rivet will be installed into the workpiece.

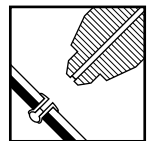

8 Release the switch. The cut mandrel will then be drawn into the tank unit.

NOTE: Make sure that the cut mandrel has been completely removed before proceeding to the next riveting.

⚠ WARNING3 (P.2)

9 Once the mandrel is about half full in the tank unit, turn the tank cap at the end of the tank in the OPEN direction to remove the cap. Then empty out the cut mandrels from inside the tank unit.

NOTE: It is strongly recommended to dispose of the spent mandrels as soon as the Mandrel collection tank become half filled. Failure to do this, jamming of the spent mandrels inside the Guide Pipe will occur and the vacuum will cease to function, resulting in a back flow of air from the Nosepiece.

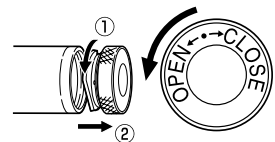

< Operating temperature > The ambient temperature for working is within the range of 4 ~ 35°C (39.2 ~ 95°F).

MAINTENANCE

After long periods of use, debris from rivet mandrel and other foreign materials tend to build up in various parts of the tool and the hydraulic oil level may drop, both of which can lead to operating problems. The tool should be cleaned periodically.

⚠ WARNING In case you have some trouble and failure, please refer “Troubleshooting” in the Instruction Manual.

1 Jaw maintenance **Also refer to this section when replacing parts.**

- ⊙ With debris builds up, the jaws will not move smoothly and normal operation will not be possible.
- ⊙ The jaws should be cleaned on average once every 3,000 riveting operations.

1 Turn off the air supply. **⚠ CAUTION1 (P.3)**

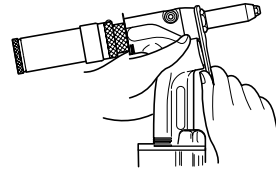

2 Use a spanner or similar tool to remove the frame head. **⚠ CAUTION2 (P.3)**

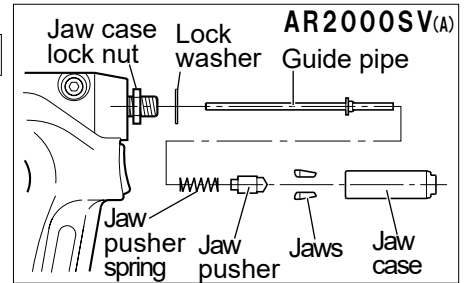

3 **AR2000SV(A)**
Use a spanner or similar tool to loosen and remove the jaw case, and then remove the jaw pusher spring, jaw pusher and jaws.

AR2000MV(A) / AR2000HV(A)
Pull backwards the jaw case collar to loosen and remove the jaw case head, and then remove the jaw pusher spring, jaw pusher, O-ring and jaws.

- ☑ If the guide pipe is hard to pull out during removal, use long nose pliers or a similar tool to pull it out.

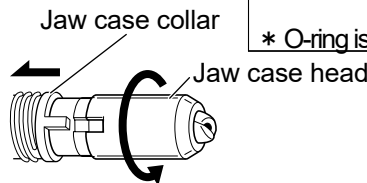
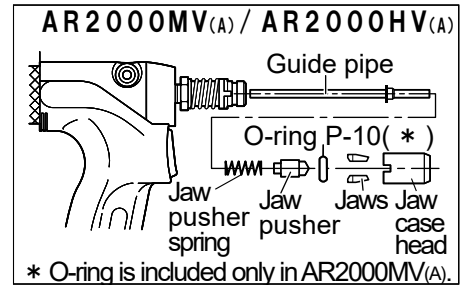

* O-ring is included only in AR2000MV(A).

DISASSEMBLY

CLEANING

4 Use a brush or similar to clean all parts.



英語 / ENGLISH

5 **AR2000SV_(A)**

Reassemble by following the disassembly procedure in reverse. Install the jaw case so that its distance matches those shown in the illustration at right.

AR2000MV_(A) / AR2000HV_(A)

Reassemble by following the disassembly procedure in reverse. Tighten the jaw case head fully, and then turn it back so that the notch is aligned with the tab on the jaw case collar, and move the collar into place.

- ❑ Apply “LOBSTER” brand jaw lube (sold separately) to the backs of the jaws.
- ❑ It will be easier to install the guide pipe if you turn the pipe while inserting it.

NOTE:

- When re-assembling, be sure to apply a lubricant such as grease to all moving and sliding parts.
- Be careful not to leave out any parts, and tighten all connections securely.
- The jaws are consumable parts, and they should be replaced periodically.
- In the case of the AR2000MV_(A) and AR2000HV_(A), the jaw case and jaw case lock nut do not need to be removed during maintenance. If they are removed by mistake, replace them so that the distance matches those shown in the illustration at right.

< Jaw case setting position >

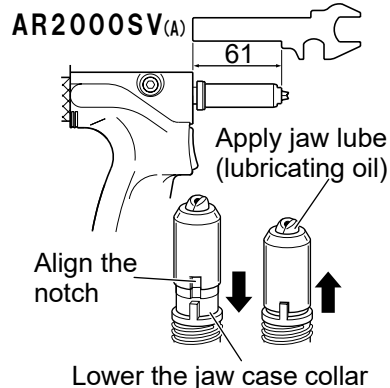

< Jaw case setting position >

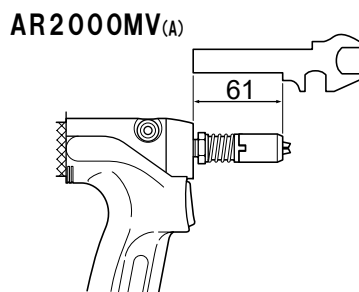

AR2000HV_(A)

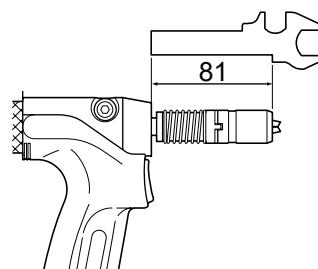

2 Cleaning and filling the cylinder

© If foreign materials build up in the cylinder, it will not operate smoothly and service life will be reduced.

DISASSEMBLY

1 Turn off the air supply. ⚠ CAUTION1 (P.3)

2 Use a spanner or similar tool to remove the frame head.

⚠ WARNING 4 (P.2)

Be sure to remove the frame head when adding hydraulic oil through the cylinder.

3 Use a Phillips screwdriver to remove the four tapping screws on the cylinder top, and then separate the cylinder and the frame.

☐ Hold the frame vertical, as the hydraulic oil will spill out if it is tipped sideways.

4 Hold the frame upside down and pull the air piston out from the cylinder top.

☐ Air Piston may remain inside Cylinder cup.

5 Remove the cylinder cup from the cylinder cover.

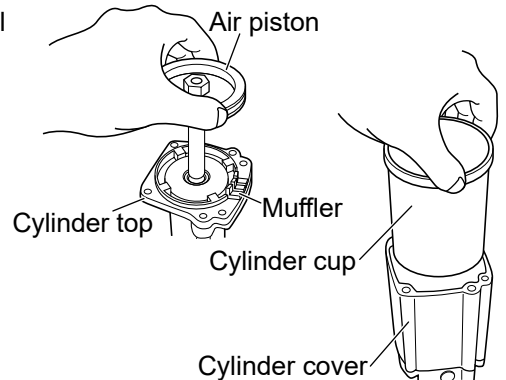
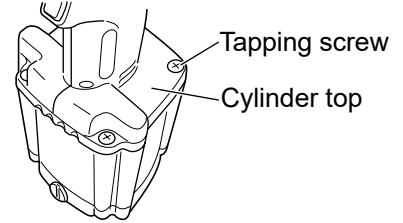
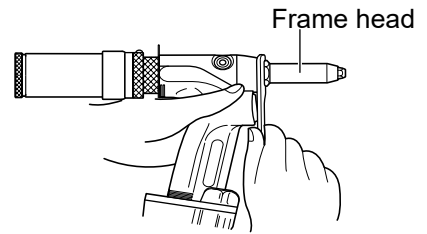

CLEANING

6 Use a rag, brush or similar to clean all parts.

FILLING OIL

7 Fill with hydraulic oil until just before the oil starts running out from the filling hole.

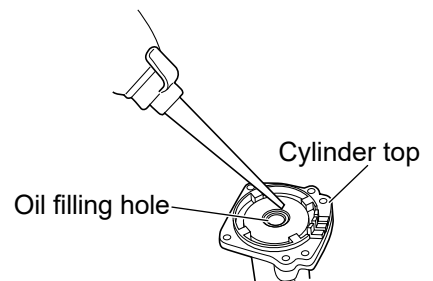

RE-ASSEMBLY

8 Apply grease to the inside of the cylinder cup and to the O-ring and rod of the air piston.

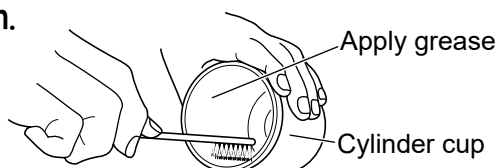

9 Put the cylinder cup back in the cylinder cover.

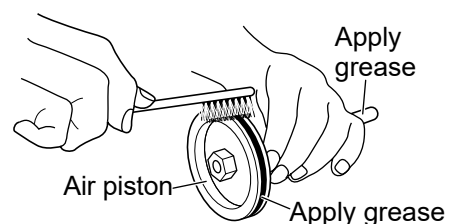

英語 / ENGLISH

10 Put the air piston back inside the cylinder cup.

❑ At that time, the air piston is susceptible to falling inside the cylinder cup. Carefully press the air piston straight to the bottom. (10-1)

If the piston is not seated straight, remove it and then press it again. Do not forcibly press the inclining piston. (10-2)

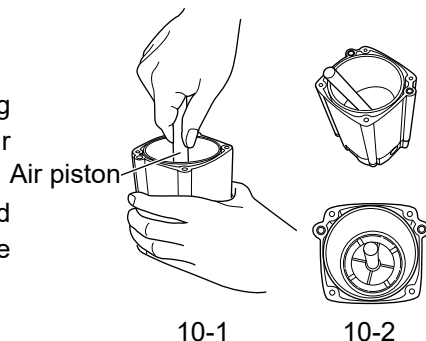

11 Put the air cylinder containing the air piston together with the cylinder top. Hold them down while fastening the four tapping screws.

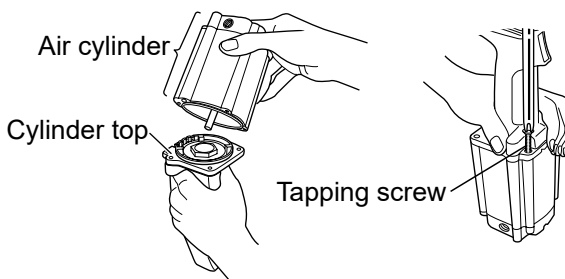

12 After all parts have been reassembled but before the frame head has been re-attached, hold the tool so that the bleed plug (hexagon socket head cap screw) is facing directly upward, and use the accessory hex key wrench to loosen the bleed plug to drain any excess oil. After checking that no more oil is coming out, re-tighten the bleed plug.

❑ Be careful when loosening the bleed plug, as the hydraulic oil may spill out rapidly.

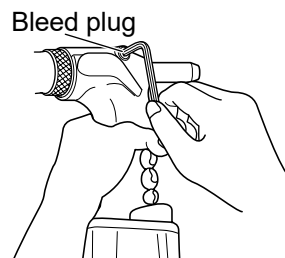

13 Wipe away any oil around the tool and clean up any spilled oil before using the tool.

⚠ CAUTION4 (P.3) ⚠ CAUTION8 (P.3)

14 After checking the jaw case setting position, install the frame head. (Refer to pages 10 and 11.)

NOTE:

- Be careful not to allow any debris or other foreign materials get into the hydraulic oil or the cylinder during disassembly and re-assembly.
- The hydraulic oil should be changed on average once every 300,000 riveting operation.

3 Cleaning the spool

DISASSEMBLY

- 1 Turn off the air supply.
⚠ CAUTION1 (P.3)
- 2 Use a spanner or similar tool to remove the change plugs at the front and back.
- 3 Use a plastic screwdriver or similar to push out the spool from the rear hole.

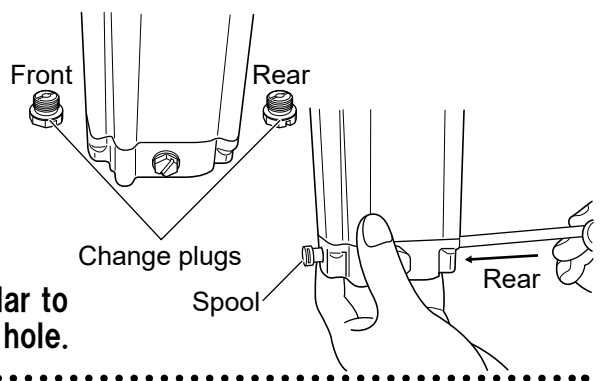

CLEANING

- 4 Use a brush or similar to clean all parts. Check the spool thoroughly to ensure that none of the small holes in the spool are blocked.

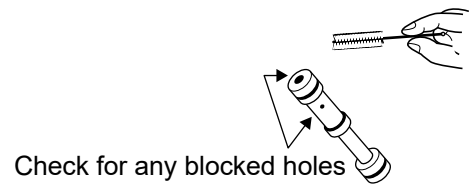

RE-ASSEMBLY

- 5 Reassemble by following the disassembly procedure in reverse.
 - ☑ Apply grease to the O-ring of the spool before reassembly.
 - ☑ The front and rear change plugs and the change plug of the air hose connector (refer to page 5) have the same shape, so be careful not to confuse them.

4 Cleaning the nozzle

DISASSEMBLY

- 1 Turn off the air supply.
⚠ CAUTION1 (P.3)
- 2 Remove the tunk unit.
- 3 Loosen the screw which is pressing the plate.
- 4 Remove the plate, and pull out the nozzle unit.
- 5 Disconnect the joint part of the nozzle unit using a plier. Clean the hole of nozzle B and the top part of nozzle A.

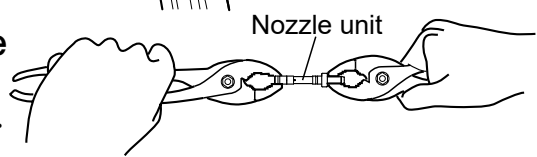
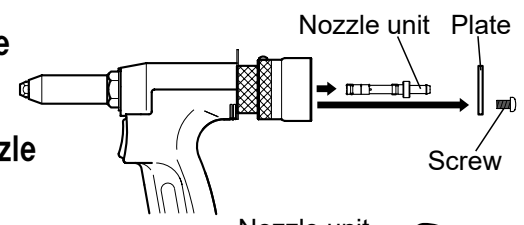
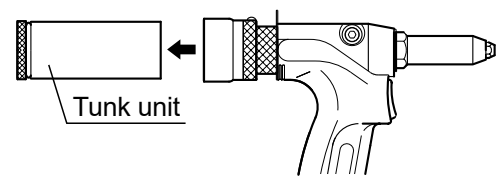

CLEANING

- 6 Use a brush or similar tool to clean the nozzle. Check for the blocked hole.

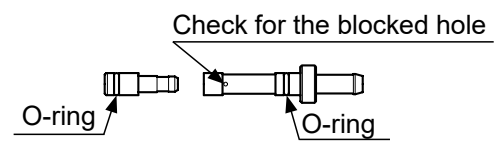

RE-ASSEMBLY

7 Reassemble by following the disassembly procedure in reverse.

- ☒ Apply grease to each O-ring before installing them.

5

Adding oil

© Oil addition should always be carried out by following the simple procedure given below.

DISASSEMBLY

1 Turn off the air supply.

⚠ CAUTION1 (P.3)

2 Use the accessory hex key wrench to remove the bleed plug and seal washer, and attach the priming pump (syringe unit) to the hole.

- ☒ Make sure that the priming pump contains the necessary amount of oil beforehand.
- ☒ If you hold the main body of the priming pump while tightening, the pump may become damaged. Hold bottom part of priming pump while tightening.

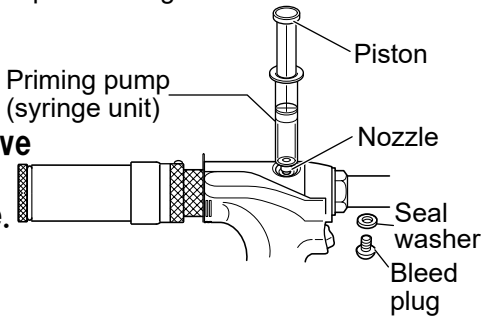

FILLING OIL

3 Gently depress the piston of the priming pump.

- ☒ When enough hydraulic oil has been added, the piston will become hard to push. Stop adding oil at this point.

RE-ASSEMBLY

4 Install the bleed plug and seal washer.

STORAGE

- Store in a place which is well-ventilated and free from excessive dust and humidity, and where there is no danger that the tool will fall.
- If the tool will not be used for a long period of time, inspect the parts as shown in "Maintenance" on pages 10 to 15 prior to storing the tool.
- To increase the working life of the tool, it is recommended that you perform the periodic overhauls. Contact the place of purchase or your nearest "LOBSTER" dealer for any overhauls and repair work required. (A charge will be made for this service.)

ULTRA JAWS (AR2000MV (A) / AR2000HV (A))

The AR2000MV(A) and AR2000HV(A) use ultra jaws which have greater durability. Be sure to specify "Ultra jaws M" (for AR2000MV(A)) or "Ultra jaws H" (for AR2000HV(A)) as replacement parts for these models.

"LOBSTER" brand Hydraulic Oil is supplied in a plastic filler bottle with the tool, and can also be obtained from your "LOBSTER" dealer or agent in your town. If this is not possible, a good quality mineral oil with the following properties should also be used.

HYDRAULIC OIL REQUIREMENTS

Use only clean hydraulic oil, as the viscosity of the oil used will affect tool performance.

Viscosity ISO	: VG46	RECOMMENDED OILS are:
Viscosity Index	: 113	
Viscosity at 40°C	: 46 c.s.t.	Shell Tellus No. 46
Viscosity at 100°C	: 7.06 c.s.t.	Esso Teresso No. 46
Flash Point	: 228	Mobil D.T.E. 25 Oil (Medium)

TROUBLESHOOTING

If a problem occurs, check the following.

If the problem persists after checking the items in the table below, contact your nearest "LOBSTER" dealer or direct to us.

In making any inquiries about this product or requests for repair work, first check the troubleshooting below and then make a note of the model number, the usage conditions and the trouble symptoms in as much detail as possible. If you can provide this kind of information, it will help in reducing the amount of time required for delivery or repairs to be completed.

Trouble	Cause	Countermeasure
The rivet does not go in, or the mandrel does not come out after riveting.	1 Incorrect combination of replacement parts being used.	Replace with the correct part which matches the rivet size. (Refer to page 8.)
	2 Nosepiece or frame head is loose.	Use a spanner or similar to tighten securely.
	3 Jaw case is incorrectly assembled.	Check the jaw case setting position. (Refer to pages 10 and 11.)
	4 Contact surfaces between the jaws and the jaw case head are not smooth.	Clean the jaws and inside the jaw case head, and apply "LOBSTER" brand jaw lube (or spray-type lubricating oil or the accessory hydraulic oil) to the backs of the jaws. (Refer to page 10.)
	5 The inside of the cylinder is dirty so that the air piston cannot return to its proper position.	Clean inside the cylinder, and apply grease inside the cylinder and to the O-ring. (Refer to pages 12 and 13.)
	6 Oil filling was not performed correctly, so that there is excess hydraulic oil inside the tool.	Loosen the bleed plug to allow the excess hydraulic oil to drain out. (Refer to page 13.)
Number of switch operations increases before riveting is complete. Or cannot complete riveting.	1 The rivet length is not correct for the workpiece thickness.	Use rivets which match the workpiece thickness.
	2 Compressor air pressure is incorrect.	Check the air pressure.
	3 Jaw case is incorrectly assembled.	Check the jaw case setting position. (Refer to pages 10 and 11.)
	4 Jaws are worn.	Replace the jaws. (Refer to page 10.)
	5 Insufficient hydraulic oil, causing a shorter stroke.	Add hydraulic oil. (Refer to page 15.)
Piston does not operate, or returns very slowly, or operation is not smooth.	1 Spool is not moving properly.	I Remove the rear part of changeplug (Refer to page 14) and push the spool 2 ~ 3 mm with a plastic (soft) stick. In case of no improvement, take the II measure.
		II Clean the spool and apply grease to the O-rings. (Refer to page 14.)
	2 Air outlet hole muffler is blocked.	Replace the muffler. (Refer to pages 12 and 13.)
3 The inside of the cylinder is dirty so that the air piston cannot return to its proper position.	Clean inside the cylinder, and apply grease inside the cylinder and to the O-ring. (Refer to pages 12 and 13.)	
The suction power is weak and the cut mandrels cannot be drawn out.	1 The air controller is not open far enough.	Please turn the air controller 1/4 of a turn. (Refer to page 9.)
	2 There are too many cut mandrels inside the tank unit.	Remove the tank cap and empty out the cut mandrels from inside the tank unit.
	3 The guide pipe is blocked with cut mandrels.	Take out the guide pipe and remove the cut mandrels which are blocking it. (Refer to page 10.)
	4 The nozzle is dirty, causing the suction power to drop.	Clean the nozzle. (Refer to page 14.)
	5 Oil filling was not performed correctly, so that there is excess hydraulic oil inside the tool, and the air holes are misaligned, causing the suction power to drop.	Loosen the bleed plug to allow the excess hydraulic oil to drain out. (Refer to page 13.)

AR2000SV(A) PARTS TABLE

● For disassembly of dotted line area () contact with your local dealer.

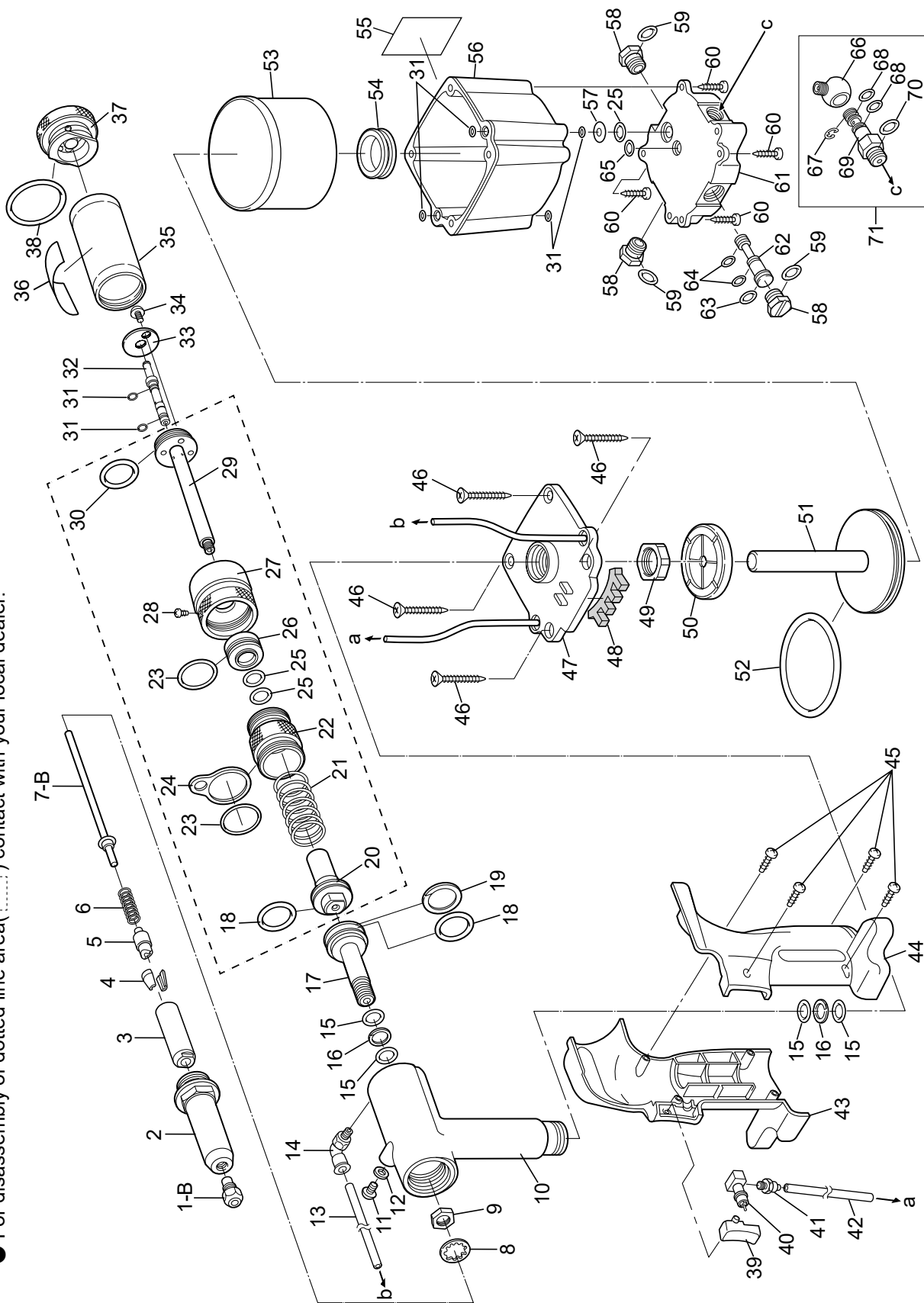

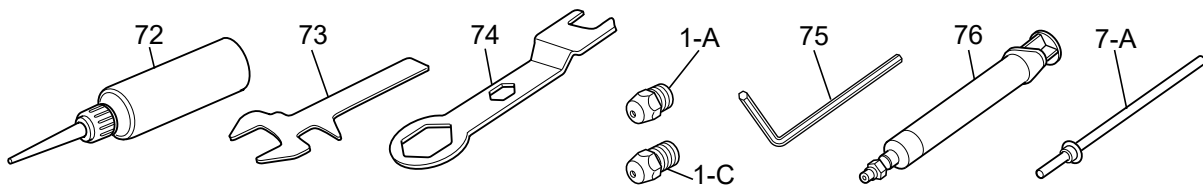

Index No.	Part name	Code No.	Material	Index No.	Part name	Code No.	Material
1-A	Nosepiece 'S' 2.4 (3/32)	10027	Steel	37	Tank cap (with O-ring)	29703	⑤
1-B	Nosepiece 'S' 3.2 (1/8)	10028	Steel	38	O-ring P-34	24311	Rubber
1-C	Nosepiece 'S' 4.0 (5/32)	10029	Steel	39	Switch	29348	Plastic
2	Frame head 'S'	29801	Steel	40	Valve sleeve	29350	⑥
③	Jaw case	10173	Steel	41	Miniature Connector	42510	③
④	Jaws (pair) 'S'	10032	Steel	42	Polyurethane tube 115 mm	44705	Plastic
⑤	Jaw pusher	10132	Steel	43	Frame cover 'MA-R'	42478	Plastic
⑥	Jaw pusher spring	10133	Steel	44	Frame cover 'MA-L'	42500	Plastic
7-A	Guide pipe 'X'	16779	Brass	45	Pan head tapping screw 3×10	29340	Steel
7-B	Guide pipe 'Y'	14492	⑦	46	Flat head tapping screw 5×35	29367	Steel
8	Lock washer	10148	Steel	47*3	Cylinder top unit	44562	④
9	Jaw case lock nut	10113	Steel	48	Muffler	29377	Plastic
10*1	Frame unit 'SA'	44561	①	49	Frame lock nut 'H'	29757	Steel
11	Bleed plug (Hexagon socket head cap screw)	29337	Steel	50	Rubber cushion 'H'	29736	Rubber
				51*4	Air piston unit 'S'	44704	⑤
12	Seal washer	63209	Rubber	52	O-ring P-60	10134	Rubber
13	Polyurethane tube 220 mm	44706	Plastic	53	Cylinder cup 'S'	29824	Aluminum
14	Connector	29354	②	54	Grommet	29361	Rubber
15	O-ring P-12	10128	Rubber	55	Warning label	61075	Plastic
16	B-ring P-12	10129	Plastic	56	Cylinder cover 'S'	29822	Plastic
17	Oil piston 'X'	41258	Steel	57	Exhaust plate	42838	Steel
18	O-ring P-18	23683	Rubber	58	Change plug	29375	Plastic
19	B-ring P-18	23684	Plastic	59	O-ring P-9	10219	Rubber
20	Flange 'X'	41212	Aluminum	60	Pan head tapping screw 4×20	29610	Steel
21	Return spring 'S'	29815	Steel	61	Cylinder bottom	29366	Aluminum
22	Frame cap 'SV'	29680	Aluminum	62	Spool	29612	Brass
22U	Frame cap unit 'SV'	29705	⑤	63	O-ring P-8 (4D)	29614	Rubber
23	O-ring S-24	10185	Rubber	64	O-ring P-5 (4D)	29613	Rubber
24	Hanger clip 'S'	29819	Steel	65	O-ring P-6	10150	Rubber
25	O-ring P-10	10274	Rubber	66	Rotary joint	42501	Aluminum
26	Air valve (with O-rings)	29701	⑧	67	Retaining ring E-7	10285	Steel
27*2	Air controller 'Y'	41222	⑨	68	O-ring P-7	10149	Rubber
28	Pan head tapping screw 3×6	29670	Steel	69	Nipple	42479	Aluminum
29	Back piston 'Y'	41215	Aluminum	70	O-ring S-10	10151	Rubber
30	O-ring P-30	14445	Rubber	71	Rotary joint unit	42502	①
31	O-ring S-5	10276	Rubber	72	"LOBSTER" brand hydraulic oil	10012	---
32	Nozzle unit (with O-ring)	41199	③	73	Spanner 'B'	29642	Steel
33	Plate	41299	Steel	74	Spanner 'A'	10183	Steel
34	Cross recessed head screw 6×10	20916	Steel	75	Hex key wrench 5 mm	25777	Steel
35	Mandrel tank 'S'	29681	Plastic	76	Priming pump (syringe unit)	29624	②
35U	Mandrel tank unit 'S'	29837	①	*5	"LOBSTER" lubricant oil JO-50	889	---
36	Caution label	22040	Plastic				

* 1 Part no. 10 includes part nos. 11, 12, 15, and 16. Part no. 22U includes part nos. 23, 24, and 25. ① Aluminum, Rubber, Steel, Plastic

* 2 Part no. 27 includes part no. 28. 35U includes part nos. 35 and 36.

* 3 Part no. 47 includes part nos. 13, 40, 41, 42, and 48.

* 4 Part no. 51 includes part nos. 50, and 52. * 5 Separately sold.

Parts with circled Index No. are consumable parts. They should be replaced periodically.

ORDERING PARTS

Indicate the tool model, part name, code no. and quantity as shown below when ordering.

Model	Part name	Code No.	Qty.
AR2000SV(A)	Jaws (pair) 'S'	10032	1
AR2000SV(A)	Frame head 'S'	29801	1

* When parts are modified for improvement, the older parts are kept in stock for a period of five years.

② Brass, Rubber, Plastic

③ Brass, Rubber

④ Aluminum, Brass,

Rubber, Stainless, Plastic

⑤ Aluminum, Rubber, Steel

⑥ Brass, Rubber, Stainless

⑦ Brass, Stainless

⑧ Plastic, Rubber

⑨ Steel, Plastic

AR2000MV (A) PARTS TABLE

● For disassembly of dotted line area () contact with your local dealer.

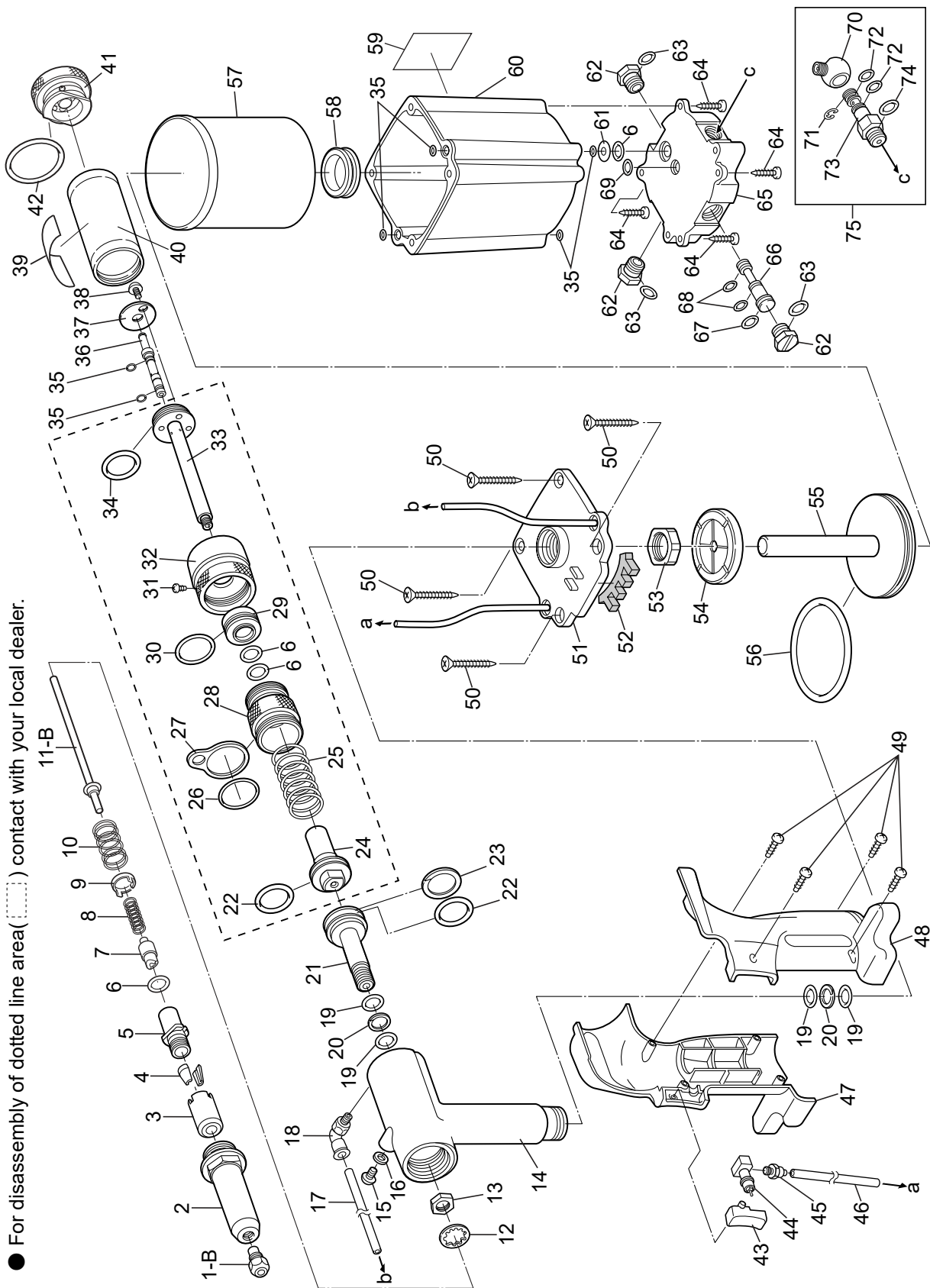

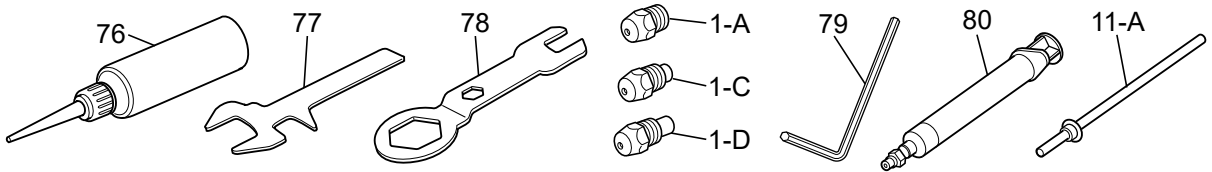

Index No.	Part name	Code No.	Material	Index No.	Part name	Code No.	Material
1-A	Nosepiece 'S' 2.4 (3/32)	10027	Steel	39	Caution label	22040	Plastic
1-B	Nosepiece 'S' 3.2 (1/8)	10028	Steel	40	Mandrel tank	29674	Plastic
1-C	Nosepiece 'S' 4.0 (5/32)	10029	Steel	40U	Mandrel tank unit	29838	①
1-D	Nosepiece 'S' 4.8 (3/16)	10030	Steel	41	Tank cap (with O-ring)	29703	⑤
2	Frame head 'M'	29332	Steel	42	O-ring P-34	24311	Rubber
③	Jaw case head	10280	Steel	43	Switch	29348	Plastic
④	Ultra Jaws (pair) 'M'	10281	Steel	44	Valve sleeve	29350	⑥
⑤	Jaw case 'M'	10279	Steel	45	Miniature Connector	42510	③
⑥	O-ring P-10	10274	Rubber	46	Polyurethane tube 115 mm	44705	Plastic
⑦	Jaw pusher	10132	Steel	47	Frame cover 'MA-R'	42478	Plastic
⑧	Jaw pusher spring	10133	Steel	48	Frame cover 'MA-L'	42500	Plastic
9	Jaw case collar	10286	Steel	49	Pan head tapping screw 3×10	29340	Steel
10	Collar spring	10287	Steel	50	Flat head tapping screw 5×35	29367	Steel
11-A	Guide pipe 'X'	16779	Brass	51*3	Cylinder top unit	44562	④
11-B	Guide pipe 'Y'	14492	⑦	52	Muffler	29377	Plastic
12	Lock washer	10148	Steel	53	Frame lock nut 'H'	29757	Steel
13	Jaw case lock nut	10113	Steel	54	Rubber cushion 'H'	29736	Rubber
14*	Frame unit 'MA'	42486	①	55*4	Air piston unit 'M'	29635	⑤
15	Bleed plug (Hexagon socket head cap screw)	29337	Steel	56	O-ring P-60	10134	Rubber
16	Seal washer	63209	Rubber	57	Cylinder cup 'M'	29360	Aluminum
17	Polyurethane tube 220 mm	44706	Plastic	58	Grommet	29361	Rubber
18	Connector	29354	②	59	Warning label	61075	Plastic
19	O-ring P-12	10128	Rubber	60	Cylinder cover 'M'	29359	Plastic
20	B-ring P-12	10129	Plastic	61	Exhaust plate	42838	Steel
21	Oil piston 'Y'	41264	Steel	62	Change plug	29375	Plastic
22	O-ring P-22A	10130	Rubber	63	O-ring P-9	10219	Rubber
23	B-ring P-22A	10131	Plastic	64	Pan head tapping screw 4×20	29610	Steel
24	Flange 'Y'	41213	Aluminum	65	Cylinder bottom	29366	Aluminum
25	Return spring 'M'	29345	Steel	66	Spool	29612	Brass
26	O-ring S-30	23685	Rubber	67	O-ring P-8 (4D)	29614	Rubber
27	Hanger clip 'M'	10106	Steel	68	O-ring P-5 (4D)	29613	Rubber
28	Frame cap 'MV'	29666	Aluminum	69	O-ring P-6	10150	Rubber
28U	Frame cap unit 'MV'	29700	⑤	70	Rotary joint	42501	Aluminum
29	Air valve (with O-rings)	29701	⑧	71	Retaining ring E-7	10285	Steel
30	O-ring S-24	10185	Rubber	72	O-ring P-7	10149	Rubber
31	Pan head tapping screw 3×6	29670	Steel	73	Nipple	42479	Aluminum
32*2	Air controller 'Y'	41222	⑨	74	O-ring S-10	10151	Rubber
33	Back piston 'Y'	41215	Aluminum	75	Rotary joint unit	42502	①
34	O-ring P-30	14445	Rubber	76	"LOBSTER" brand hydraulic oil	10012	----
35	O-ring S-5	10276	Rubber	77	Spanner 'B'	29642	Steel
36	Nozzle unit (with O-ring)	41199	③	78	Spanner 'A'	10141	Steel
37	Plate	41299	Steel	79	Hex key wrench 5 mm	25777	Steel
38	Cross recessed head screw 6×10	20916	Steel	80	Priming pump (syringe unit)	29624	②
				*5	"LOBSTER" lubricant oil JO-50	889	----

- * 1 Part no. 14 includes part nos. 15, 16, 19, and 20. Part no. 28U includes part nos. 26, 27, and 6. ① Aluminum, Rubber, Steel, Plastic
 * 2 Part no. 32 includes part no. 31. 40U includes part nos. 39 and 40. ② Brass, Rubber, Plastic
 * 3 Part no. 51 includes part nos. 17, 44, 45, 46, and 52. ③ Brass, Rubber
 * 4 Part no. 55 includes part nos. 54, and 56. * 5 Separately sold. ④ Aluminum, Brass, Rubber, Stainless, Plastic
 ⑤ Aluminum, Rubber, Steel
 ⑥ Brass, Rubber, Stainless
 ⑦ Brass, Stainless
 ⑧ Plastic, Rubber
 ⑨ Steel, Plastic

Parts with circled Index No. are consumable parts. They should be replaced periodically.

ORDERING PARTS

Indicate the tool model, part name, code no. and quantity as shown below when ordering.

Model	Part name	Code No.	Qty.
AR2000MV(A)	Ultra Jaws (pair) 'M'	10281	1
AR2000MV(A)	Frame head 'M'	29332	1

* When parts are modified for improvement, the older parts are kept in stock for a period of five years.

AR2000HV (A) PARTS TABLE

● For disassembly of dotted line area () contact with your local dealer.

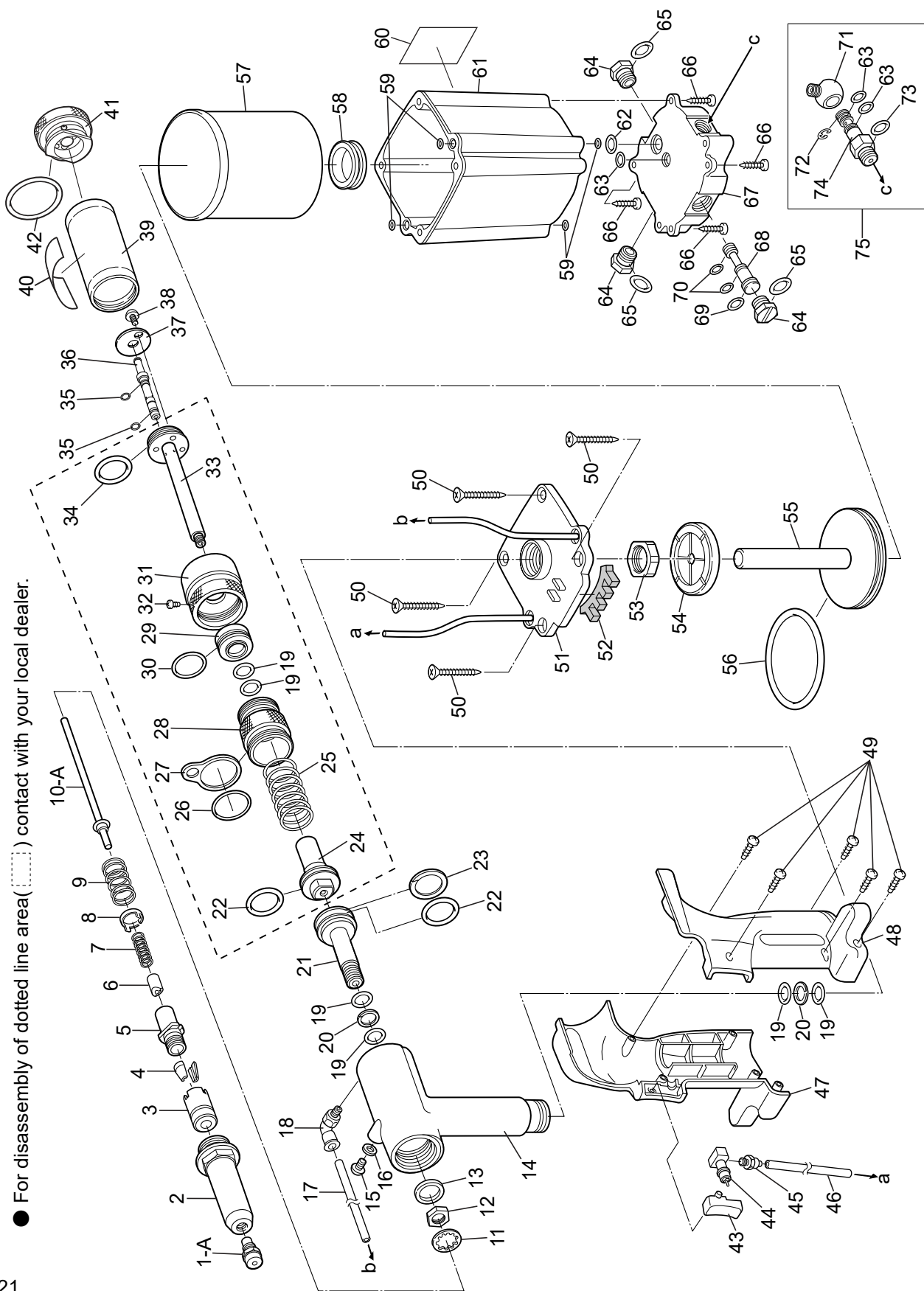

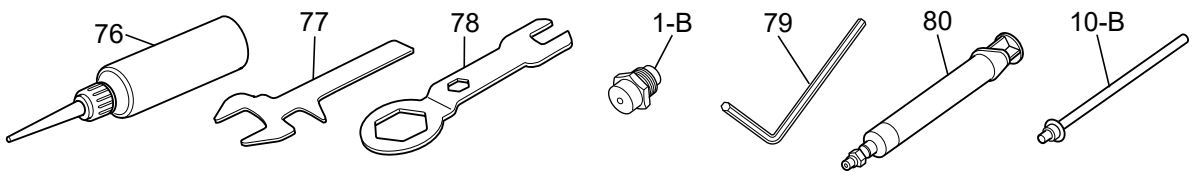

Index No.	Part name	Code No.	Material	Index No.	Part name	Code No.	Material
1-A	Nosepiece 'L' 4.8 (3/16)	10216	Steel	39U	Mandrel tank unit	41149	①
1-B	Nosepiece 'H' 6.4 (1/4)	10226	Steel	40	Caution label	22040	Plastic
2	Frame head 'H'	29709	Steel	41	Tank cap (with O-ring)	29703	⑤
③	Jaw case head 'H'	10447	Steel	42	O-ring P-34	24311	Rubber
④	Ultra Jaws (pair) 'H'	10493	Steel	43	Switch	29348	Plastic
⑤	Jaw case	10429	Steel	44	Valve sleeve	29350	⑥
⑥	Jaw pusher 'H'	29710	Steel	45	Miniature Connector	42510	③
⑦	Jaw pusher spring 'H'	29711	Steel	46	Polyurethane tube 125 mm	29729	Plastic
8	Jaw case collar	10448	Steel	47	Frame cover 'HA-R'	44551	Plastic
9	Collar spring	10449	Steel	48	Frame cover 'HA-L'	44552	Plastic
10-A	Guide pipe 'E' 4.8 (3/16)	41203	Steel	49	Pan head tapping screw 3×10	29340	Steel
10-B	Guide pipe 'F' 6.4 (1/4)	29752	⑦	50	Flat head tapping screw 5×35	29367	Steel
11	Lock washer	10148	Steel	51*3	Cylinder top unit 'HA'	43586	④
12	Jaw case lock nut 'H'	29712	Steel	52	Muffler 'HA'	44567	Plastic
13	Stop ring	23634	Steel	53	Frame lock nut 'H'	29757	Steel
14*1	Frame unit 'HA'	44703	①	54	Rubber cushion 'H'	29736	Rubber
15	Bleed plug (Hexagon socket head cap screw)	29337	Steel	55*4	Air piston unit 'H'	29758	⑤
16	Seal washer	63209	Rubber	56	O-ring P-70	10212	Rubber
17	Polyurethane tube 230 mm	29730	Plastic	57	Cylinder cup 'H'	29741	Aluminum
18	Connector	29354	②	58	Grommet	29361	Rubber
19	O-ring P-12	10128	Rubber	59	O-ring S-5	10276	Rubber
20	B-ring P-12	10129	Plastic	60	Warning label	61075	Plastic
21	Oil piston 'Z'	41270	Steel	61	Cylinder cover 'H'	29740	Plastic
22	O-ring P-24	10207	Rubber	62	O-ring P-10	10274	Rubber
23	B-ring P-24	10208	Plastic	63	O-ring P-7	10149	Rubber
24	Flange 'Z'	41214	Aluminum	64	Change plug	29375	Plastic
25	Return spring 'H'	29726	Steel	65	O-ring P-9	10219	Rubber
26	O-ring S-32	29727	Rubber	66	Pan head tapping screw 4×20	29610	Steel
27	Hanger clip	10192	Steel	67	Cylinder bottom 'H'	29739	Aluminum
28	Frame cap 'HV'	29690	Aluminum	68	Spool	29612	Brass
28U	Frame cap unit 'HV'	29831	⑤	69	O-ring P-8 (4D)	29614	Rubber
29	Air valve 'H' (with O-rings)	29832	⑧	70	O-ring P-5 (4D)	29613	Rubber
30	O-ring S-24	10185	Rubber	71	Rotary joint	42501	Aluminum
31*2	Air controller 'Y'	41222	⑨	72	Retaining ring E-7	10285	Steel
32	Pan head tapping screw 3×6	29670	Steel	73	O-ring S-10	10151	Rubber
33	Back piston 'Z'	41216	Aluminum	74	Nipple	42479	Aluminum
34	O-ring P-30	14445	Rubber	75	Rotary joint unit	42502	①
35	O-ring S-7	12114	Rubber	76	"LOBSTER" brand hydraulic oil	10012	---
36	Nozzle unit (with O-ring)	41201	③	77	Spanner 'B'	29642	Steel
37	Plate	41299	Steel	78	Spanner 'A'	10217	Steel
38	Cross recessed head screw 6×10	20916	Steel	79	Hex key wrench 5 mm	25777	Steel
39	Mandrel tank	41146	Plastic	80	Priming pump (syringe unit)	29624	②
				*5	"LOBSTER" lubricant oil JO-50	889	---

*1 Part no. 14 includes part nos. 13, 15, 16, and 20. Part no. 28U includes part nos. 26, 27, and 19. ① Aluminum, Rubber, Steel, Plastic

*2 Part no. 31 includes part no. 32. 39U includes part nos. 39, and 40.

*3 Part no. 51 includes part nos. 17, 44, 45, 46, and 52.

*4 Part no. 55 includes part nos. 54, and 56. *5 Separately sold.

Parts with circled Index No. are consumable parts. They should be replaced periodically.

ORDERING PARTS

Indicate the tool model, part name, code no. and quantity as shown below when ordering.

Model	Part name	Code No.	Qty.
AR2000HV(A)	Ultra Jaws (pair) 'H'	10493	1
AR2000HV(A)	Frame head 'H'	29709	1

* When parts are modified for improvement, the older parts are kept in stock for a period of five years.

② Brass, Rubber, Plastic

③ Brass, Rubber

④ Aluminum, Brass,

Rubber, Stainless, Plastic

⑤ Aluminum, Rubber, Steel

⑥ Brass, Rubber, Stainless

⑦ Brass, Stainless

⑧ Plastic, Rubber

⑨ Steel, Plastic

WARRANTY & SERVICE

LOBSTER[®] WARRANTS THAT GOODS COVERED BY THIS MANUAL WILL CONFORM TO APPLICABLE SPECIFICATIONS AND DRAWINGS AND THAT SUCH GOODS WILL BE MANUFACTURED AND INSPECTED ACCORDING TO GENERALLY ACCEPTED PRACTICES OF COMPANIES MANUFACTURING INDUSTRIAL TOOLS. THERE ARE NO WARRANTIES WHICH EXTEND BEYOND THE FOREGOING.

THE LIABILITY OF LOBSTER[®] ON PARTS FOUND TO BE DEFECTIVE IS LIMITED TO RE-WORK OR THE REPLACEMENT OF SUCH GOODS AND IN NO CASE TO EXCEED THE INVOICE VALUE OF THE SAID GOODS. UNDER NO CIRCUMSTANCES WILL LOBSTER[®] BE LIABLE FOR DAMAGES OR COSTS INCURRED BY THE BUYER OR SUBSEQUENT USER IN REPAIRING OR REPLACING DEFECTIVE GOODS.

ROUTINE MAINTENANCE AND REPAIR OF LOBSTER[®] RIVET TOOLS CAN BE PERFORMED BY AN AVERAGE MECHANIC. HOWEVER, IF YOU HAVE A LOBSTER[®] RIVET TOOL THAT IS IN NEED OF MAJOR REPAIR WE RECOMMEND THAT IT BE SENT DIRECTLY TO US POSTAGE PAID FOR SERVICE AT A REASONABLE CHARGES.

MANUFACTURER

LOBTEX CO., LTD.

OSAKA, JAPAN