



AIR RIVETER CE

INSTRUCTION MANUAL

BUILT-IN ON-DEMAND
VACUUM SYSTEM

ARV-025M

CONTENTS

INTRODUCTION.....	1
IMPORTANT SAFETY INSTRUCTIONS.....	2
NOMENCLATURE.....	5
TECHNICAL DATA.....	6
PREPARATION BEFORE USE.....	7
OPERATING THE AIR RIVETER.....	9
MAINTENANCE.....	10
STORAGE.....	15
ORDERING PARTS.....	15
PARTS TABLE.....	16
TROUBLESHOOTING.....	20



Professional model of air riveter to install blind rivets.

- Thank you very much for purchasing “LOBSTER” air riveter. To ensure correct operation, please carefully read this instruction manual and keep it in a safe place for later reference.
- This is Original instructions.

MANUFACTURER

LOBTEX CO.,LTD.
International Marketing&Sales Division

12-8 Shijo-cho, Higashi-Osaka City
Osaka 579-8053, Japan

Telephone: +81(72)981-7466 Telefacs: +81(72)981-9420

URL <https://www.lobtex.co.jp/>

PRINTED IN JAPAN

英語 / ENGLISH

● INTRODUCTION

Thank you very much for purchasing “LOBSTER” air riveter.

- These are the blind rivet tools which is only used for fixing blind rivets. These tools are not designed for other purposes.
- This instruction manual shows how to use the tools safely, work properly, maintenance and inspection which will make tools more effectively.
- Please check the blind rivets specification and durability on customers side before using it.

1 IMPORTANT NOTICES

- Read this manual carefully before using this tool. Follow instructions in this manual for handling this tool, replacing accessories or replacing parts as needed.
- If you have any questions about this manual, contact the “LOBSTER” dealer where you purchased the tool.
- It is impossible to foresee all potential dangers and describe them in this manual. You must operate this tool paying attention to safety as well as observing the instructions in this manual.
- This manual is translated from Japanese, its original language. It is your own responsibility to achieve a full understanding of the contents of this manual before using the equipment described.
- Lobtex Co., Ltd. has the copyright of this manual. It is prohibited to publish, copy or translate to other language without prior consent.

2 INDEMNIFICATION

- Our warranty does not apply to direct and indirect damages and lost income caused by the misuse, abuse, and unauthorized modification of the tool.
We do not guarantee the strength or quality of blind rivet.
- We do not guarantee any damages and failures caused by any modifications without our written approval.
- We do not guarantee any damages and failures caused by use of parts other than our recommendation.

● IMPORTANT SAFETY INSTRUCTIONS



- ◆ Be sure to read the following Important Safety Instructions carefully and make sure that you understand them thoroughly before using this tool.



- ◆ Always wear protective goggles while using the tool.
The rivets may jump out by accident and cause injuries.



- ◆ This is the safety alert symbol. It is used to alert you to potential personal injury hazards. Obey all safety messages that follow this symbol to avoid possible injury or death.

- ◆ These Important Safety Instructions are divided into **⚠ WARNING** and **⚠ CAUTION**.
The differences between these two levels are described below.

⚠ WARNING: Indicates a potentially hazardous situation which, if ignored, may result in death or serious injury to the operator.

⚠ CAUTION: Indicates a potentially hazardous situation which, if ignored, may result in moderate injury to the operator or physical damage.

Moreover, failure to follow the instructions marked with the **⚠ CAUTION** symbol or cautions without a **⚠ CAUTION** symbol which appear in the text of this manual may also have serious results in some cases. Always be sure to observe the instructions given in the Important Safety Instructions.

- ◆ After reading this manual, keep it in a safe place where it is easily accessible to all users.

⚠ WARNING

- 1.The air pressure should be kept within the range of 0.5 to 0.6 MPa.**
 - If an air pressure which is greater than this is used, the tool may become damaged, and injury or damage to property may result.
- 2.Never look into the nosepiece of the tool, and never point the nosepiece toward other persons.**
 - If the tool is used while the cut mandrels are still inside the tool not being ejected these mandrels may be ejected from the tool's nosepiece during use and cause serious injury.
- 3.Never direct the end of the chute hose (vent of cut rivet mandrels) toward any person.**
 - Cut rivet mandrels may be blasted off from the end of the chute hose and may cause injury.
- 4.Make sure to put the Chute Hose when using.**

Always wear protective goggles while you use the tool.

 - Spent mandrels may come out and cause the injuries.
 - Make sure to put the Chute Hose properly all the way (Nozzle Unit).
If the Chute Hose was not set properly, the hose may fall off and cause injuries.
- 5.Make sure that the tool and the air source are connected securely.**
 - If the threads of the joints do not match or if the screws are not inserted far enough, the air hose may become disconnected during use and injury may result.
 - Use hose bands to securely connect the air hose joint and air hose. If they are not securely connected, the air hose may become disconnected during use and injury may result.
- 6.Turn off the air supply before disconnecting the tool from the air source.**
 - Compressed air may cause the air hose to whip around and injury may result.
- 7.Check that all the tool parts are free from damage before use. Any damaged parts should be repaired before the tool is used.**
 - If the tool is used while any parts are damaged, injury may result.
 - If the tool is damaged by objects being dropped onto it, the damaged part may break and accident or injury may result.
 - Don't pull and drag the tool by the air hose. It may trigger some damages on the tool body, breakage of Rotary Joint or some other defects and lead serious troubles with injuries.
- 8.If using in elevated locations, use a safety harness, and take care to avoid dropping rivets or the tool itself.**
 - Accident or injury may result if this practice is not followed.



CAUTION

- 1. Before starting maintenance or disassembling the unit to replace parts, be sure to stop air supply.**
 - Performing maintenance or disassembly with air supplied may cause a part to jump out, oil to squirt out, or the unit to perform unexpectedly, and may result in an accident or personal injury.
- 2. Tighten the Bleed Plug firmly before use.**
 - If the bleed Plug is loose or coming off during use, oil may squirt out resulting in an accident or personal injury.
- 3. Do not operate the tool without equipped the frame head.**
 - Items such as fingers or a hand may become caught in the mechanism.
- 4. Do not bring your face close to the air outlet holes.**
 - Pressurized air containing fine particles is discharged from the air outlet holes during use. Keep eyes away from this area.
- 5. Avoid skin contact with substances such as hydraulic oil, lubricating oil and grease.**
 - Such substances may cause inflammation of the skin. If they come into contact with your skin, wash the affected area thoroughly.
- 6. The parts to be used must be those supplied from Lobtex or recommended by Lobtex. Select and attach parts applicable to your rivet.**
 - Otherwise the unit may not produce maximum performance and may malfunction resulting in an accident or personal injury.
- 7. Make sure that the workplace is safe, clean and organized.**
 - Accidents can easily occur in untidy workplaces.
 - If the cut mandrels are allowed to fall onto the floor, you may slip on them, and injury may result.
- 8. Avoid uncomfortable postures while working.**
 - You may fall down and injury may result.
- 9. Keep people who are not involved in work away from the workplace.**
 - Accidents or injury may result.
- 10. Maintain the tool with care.**
 - Refer to the Instruction Manual for details on replacing parts and attachments, otherwise injury may occur.
- 11. Keep the hand grip dry and clean, and avoid adhesion of oil and grease.**
 - Otherwise the grip may slip from your hand resulting in falling of the unit.
- 12. Do not leave the floor littered with cut mandrels.**
 - Cut mandrels are dangerous because their ends are sharp. Stepping on them is also dangerous easily causing a slip and fall accident.
- 13. Use the tool carefully and concentrate on correct operation at all times.**
 - Use the tool with proper care, paying full attention to methods of handling and operation and surrounding conditions. Accidents and injury may result if this practice is not followed.
 - Use common sense at all times, otherwise accidents or injury may result.
 - When you are tired, do not use the tool, otherwise accidents or injury may result.
- 14. Ask Lobtex to carry out any repair work required.**
 - Repair work should only be carried out by a qualified technician. Please contact your nearest "LOBSTER" distributor, representative, or direct to Lobtex Co., Ltd., Osaka. If the tool is repaired by someone without the necessary qualifications and experience, the tool may not perform to optimum standards, and accidents or injury may result.
- 15. Do not attempt to modify the tool.**
 - Unauthorized modifications may cause malfunctions which can lead to accidents or injury.
- 16. When disposing of the tool or packing materials, observe local laws and codes on waste disposal.**
- 17. Do not remove rubber bellows at swivel joint in the end of oil pressure hose.**
 - Otherwise, your finger or a hand may be pinched.



CAUTION

18. Do not remove the protective tube that enfolds oil pressure hose. If protective tube is damaged, stop using it and repair or replace it.
 - Protective tube protects oil pressure and prevents danger in case that oil pressure hose is broken. Dysfunction of protective tube may cause accident or injury.
19. Manufacturing date of this product is shown at the bottom of Air Cylinder Cap by brevity code and 4 digit numbers. (Refer to P.6)
20. Warning labels include important information and tips on using the machine. If the labels become so dirty or damaged that they cannot be read, order and replace them with new labels. You can order new labels from Lobtex Co., Ltd. through our dealers.
21. This product is a tool for exclusive use of the professional business. When you are the one who uses this tool for the first time, please receive an instruction from the one who has already used this tool before, also please read the Instruction Manual carefully and understand the content.
 - Wear protective goggles or safety glasses.
 - If the tool is broken, do not operate.
22. For the maintenance of the main body, for every 30,000 installation of the fastener or in one year.
23. Only persons who are well trained and qualified should use, adjust, and maintain this product.
24. Do not modify the tool. Any modification to the equipment impairs the validity of safety devices, leading to a higher risk to operators.
25. Slip, trips and falls are major causes of workplace injury. Be aware of slippery surfaces caused by use of the tool and also of trip hazards caused by the air line or hydraulic hose.
26. Proceed with care in unfamiliar surroundings. There can be hidden hazards, such as electrical or other utility cables.
27. This machine is not intended for use in potentially explosive atmospheres and is not insulated against contact with electric power.
28. Ensure that there are no electrical cables, gas pipes, etc., which can cause a hazard if damaged by use of the tool.
29. If you experience numbness, tingling, pain or whitening of the skin in your fingers or hands, stop using the tool, inform your employer and consult a physician.
30. Compressed air can cause severe injury:
 - Be sure to disconnect the tool from the air supply source when it is not in use or before replacing or repairing it.
 - Never direct air at yourself or anyone else.
31. Whipping hoses can cause severe injury.
Always make sure there are no damages on hoses and no loose fittings.
32. Do not carry the pneumatic tool by holding the hose.
33. Preventative maintenance should be carried out, after a specified time of operation, a specified number of cycles/operations or a stated number of times per year.
34. When you handle oil or grease, obtain the material safety data sheet (SDS) from the supplier, and follow the described instructions.
35. Safety valve must not be removed or disassembled.
Safety valve is an especially important safety device. If it is accidentally loosened or damaged, consult with the store you purchased the tool or Lobtex Co, Ltd.
36. Do not use the tool without resetting safety valve after it blows off.
37. If safety valve still blows off after adjusting air pressure, stop using the tool and consult with a sales office of Lobtex Co, Ltd.

NOMENCLATURE

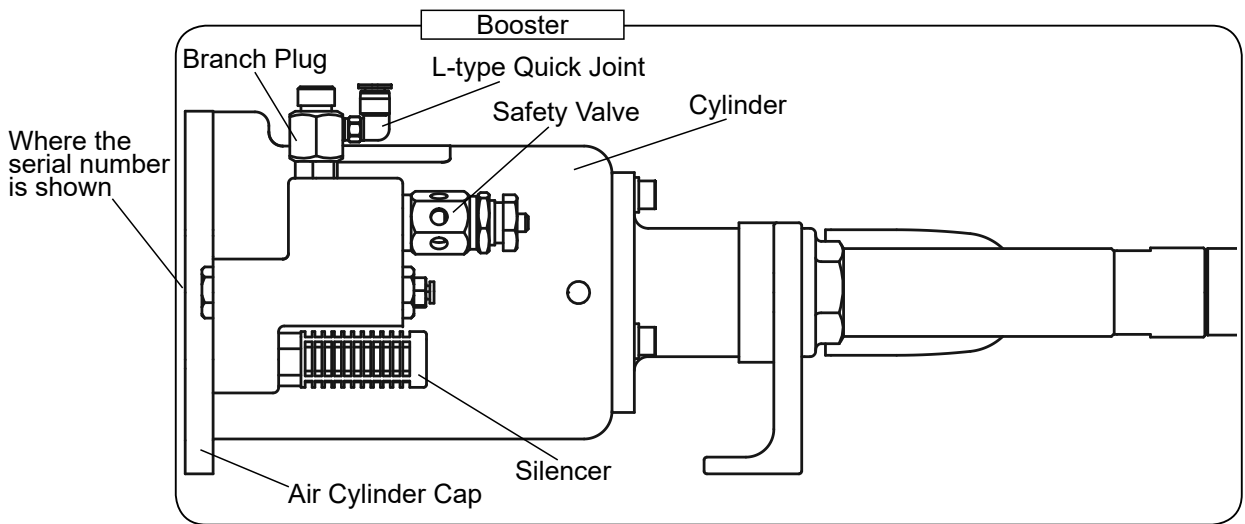
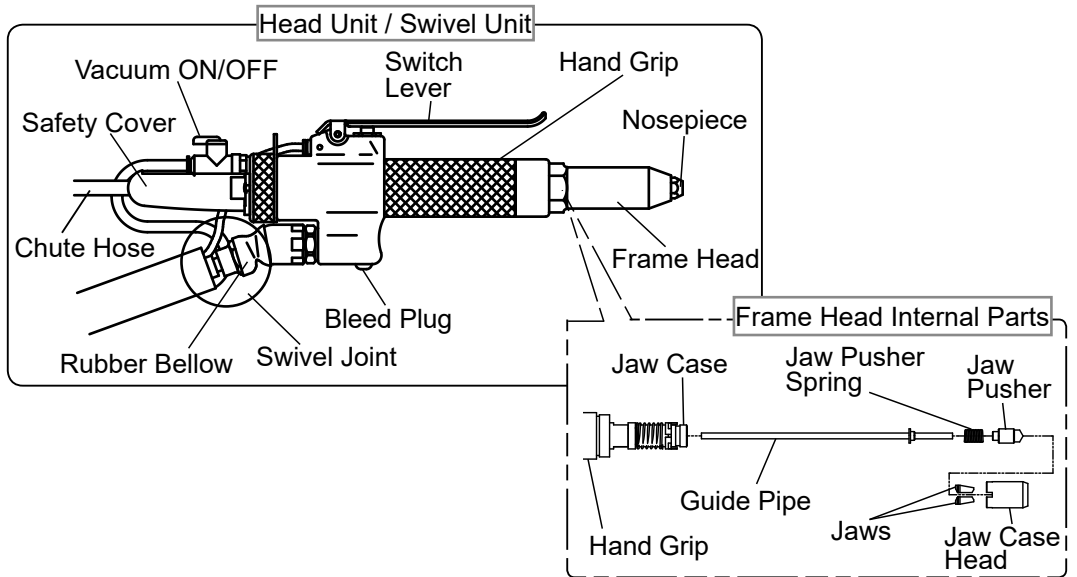

TECHNICAL DATA

Model NO.		ARV-025M
Weight	Head (kg)	0.9
	Total (kg)	4.6
Operating air pressure (MPa)		0.5 ~ 0.6
Dimensions (Length x Height x Thickness) mm (Head Unit)		310X80X39
Air consumption per minute at 0.5MPa L/min * ①		100
Tool stroke (mm)		19
Traction power at 0.5MPa (kN)		8.8
Applicable rivets (Rivet diameters) (φ mm)		2.4 · 3.2 · 4.0 · 4.8
Operating environment	Temperature	4°C to 35°C
	Relative humidity	80% RH max (no condensation)
Sound Pressure level * ② (Lpa)		75.3 dB
Vibration at 0.6MPa (Emission value)		Less than equal to 2.5m/sec ²
Air intake		Nipple screw size G1/4

- * Product specifications and design are subject to change for improvement without notice.
- * Weight and dimensions given are standard values.
Actual products may differ slightly from the values given.
- * Attaching position of rating plate (attention/caution label) is lateral side of air cylinder.
- * Serial number is shown at the bottom of air cylinder cap by brevity code and 4 digit numbers.
- * ① Under the condition of 30 pcs./min.
- * ② Measured at equivalent noise measurement level.

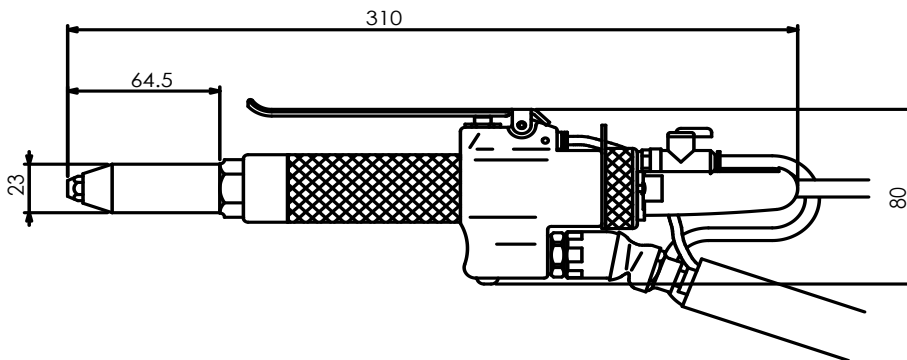

How to read the year and month of production

A year/month of manufacture	1	2	3	4	5	6	7	8	9	10	11	12
An English character	A	B	M	N	K	W	T	Y	U	O	L	Z

Example

year: 2017 month: 1 → TA ○○○○
 ↓ ↓ ↓
 T A (Serial No.)

Revision history of instruction manual
Item : Air Riveter
Model : ARV-025M
Date of seventh edition: April , 2021

● PREPARATION BEFORE USE

1 Set up a correct nosepiece and a correct guide pipe according to the size of rivet to be used. (Refer to page 10.)

*Default setup is 3.2 mm-diameter nosepiece and yellow guide pipe.

Rivet Size (Rivet Diameter)	Nosepiece	Guide Pipe
Φ 2.4	2.4	A (Yellow)
Φ 3.2	3.2	
Φ 4.0	4.0	B (White)
Φ 4.8	4.8	

Nosepiece



Die Stamp for Size

Guide Pipe

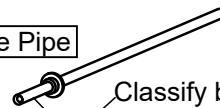

Classify by color
A: Yellow
B: White

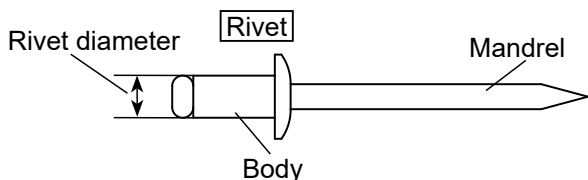

2 Fix the end of chute hose to the mandrel containing case.

Fix the either end of the chute hose to the containing case or else, so that it does not loose during operation. There must be enough space in the end of the chute hose. Lack of space or obstacles in the end of the chute hose may prevent a mandrel of cut rivet from being discharged or cause degradation in discharge power.

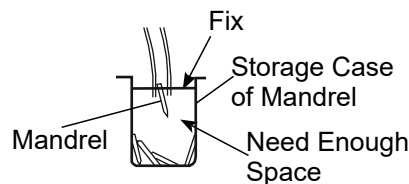

⚠ WARNING 3 (P.2)

*Be sure to prepare a containing case, to prevent the mandrel from being blasted off.
Cut rivet mandrels may be blasted off from the end of the chute hose and may cause injury.

3 Prepare an air compressor. Be sure to place an air filter and an air regulator between the compressor and the air riveter.

Complete Air Supply System

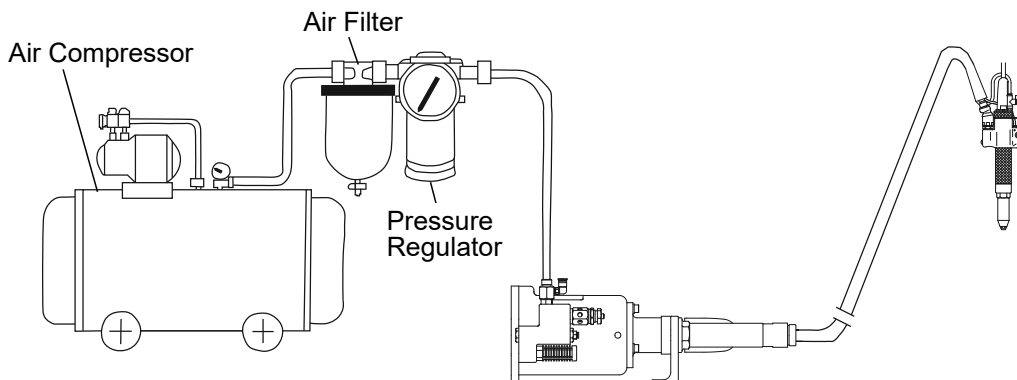

4 Set up 0.5 to 0.6 MPa as air pressure.

⚠ WARNING 1 (P.2)

*Too much pressure may cause damage to the tool. Too low pressure may cause incomplete rivetting or incomplete cutting.

5 Make sure that the tool works properly.
After connection with air, make sure that the tool works smoothly without oil leak by idle run (operating 2 or 3 times without rivets.)

Important

The tool needs careful cleaning and maintenance if it is not used for a long time.
(Ref: "P10. Cleaning the Frame head and jaw case") After cleaning and maintenance, vacuum mechanism must be operated before use.

6 SAFETY VALVE

This tool incorporates a "safety valve" that blows off air to indicate the abnormality when too much air is supplied to the riveter.

Pressure: 0.5 to 0.6 MPa

Blow off air pressure: 0.64MPa

Appropriate air

(1) Stop using the tool immediately, and stop the air supply.

Important Safety valve cannot be reset without stopping air supply.

(2) Setup the air pressure to the range between 0.5 and 0.6 MPa.

(3) Supply air again and confirm that the safety valve does not blow off.

⚠ CAUTION 35 (P.4)

Safety valve must not be removed or disassembled.

Safety valve is an especially important safety device. If it is accidentally loosened or damaged, consult with the store you purchased the tool or Lobtex Co, Ltd.

⚠ CAUTION 36 (P.4)

- Do not use the tool without resetting safety valve after it blows off. It may cause damage of the tool.

⚠ CAUTION 37 (P.4)

- If safety valve still blows off after adjusting air pressure, stop using the tool and consult with a sales office of Lobtex Co, Ltd.

● OPERATING THE AIR RIVETER

1 Select a suitable size of rivet for the workpiece to be riveted.

2 Replace the nosepiece with one which matches the size of the rivet to be used.
(Refer to item in “Preparation Before Use” on page 7.)

3 Drill a hole of appropriate size (0.1 to 0.2mm larger than the diameter of the rivet) into the workpiece.

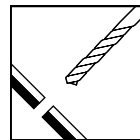

4 Turn the vacuum air cock to counter clockwise to activate the vacuum device.
The vacuum device is activated. You can hear the vacuum noise.

Important Do not use the air cock at halfway position, but turn to the end position it stops.

Important (Use vacuum system after doing P.7 “PREPARATION BEFORE USE” .)

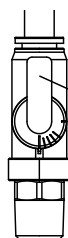

Air Cock

Condition of Vacuum Activated
(Air sound comes out)



Air Cock

Condition of Vacuum Inactivated
(Air stops)

5 Insert a rivet mandrel into the Nosepiece of the riveter.

Important Rivet is not dropped because it is vacuumed up.

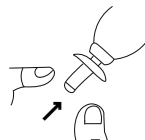

6 Insert the rivet body into the work piece hole.

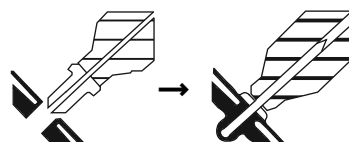

7 Press the body collar onto the material and grip the switch lever.
• The body is crimped.

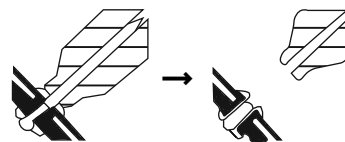

8 When the switch lever is released, the mandrel is automatically evacuated in the chute hose.

Important The Next crimping operation must be done only after the cut mandrel is evacuated.

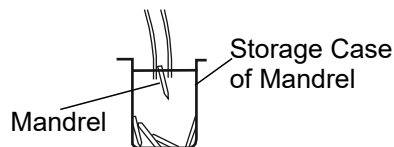

● MAINTENANCE

Riveting for a long time generates chips and dust at several parts, which causes troubles. The tool needs periodical cleaning and maintenance according to this manual.

⚠ WARNING Before cleaning and maintenance of each part, make sure that the power of air compressor is turned off to stop air supply and eliminate the residual pressure. Otherwise, you may be injured.

⚠ CAUTION

- When assembling each part, apply lubricant agent such as grease at each sliding area without fail. Otherwise, malfunction may occur.
- All parts must be completely assembled and all fastening areas must be fastened.

1 Cleaning the Frame head and Jaw case head section

If chips are clogged, jaw cannot work smoothly. Cleaning must be performed in every 3000 times of crimping.

Important

- Jaw is a consumable supply. It must be replaced periodically. This tool uses high-endurance hard tool material jaw (optional parts). When you order the part, order "hard tool material jaw, medium".
- Do not loosen or remove an oil retaining screw. The oil retaining screw is used for air vent during assembly.
- Do not loosen or remove a jaw case or lock nut of jaw case. If it is loosened or removed, oil is leaked from head area, which cause malfunction. Jaw case and lock nut of jaw case are mounted at screw unit of oil piston so that they are not loosened. If they are accidentally loosened during operation or during maintenance, ask repair.

DISASSEMBLY

- 1 Stop air supply.
- 2 Remove the frame head with auxiliary spanner A.
- 3 Pull Collar to the direction shown in the figure to loosen jaw case head and remove it.
- 4 Remove jaw pressure spring, guide pipe, jaw pressure and jaw.

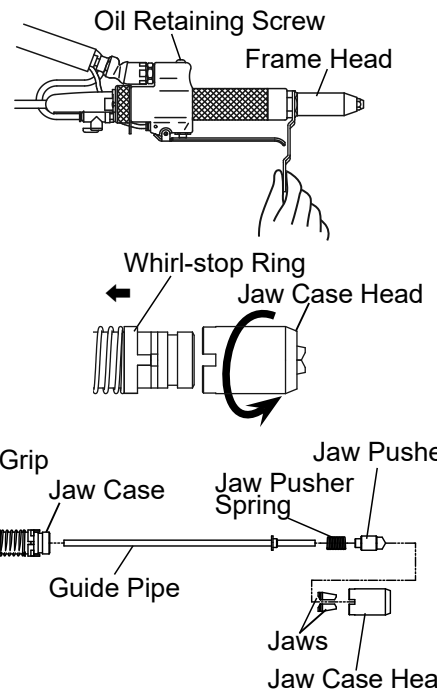

CLEANING

- 5 Clean up each part with a brush.

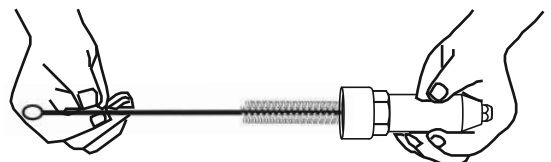

英語 / ENGLISH

RE-ASSEMBLY

6 Assemble parts in reverse procedure of disassembly. Wind and tighten jaw case head to the end and return it to the position where convex and notch are aligned, then set up Collar. At assembly, apply lubricant oil JO-50 on the backside of jaw.

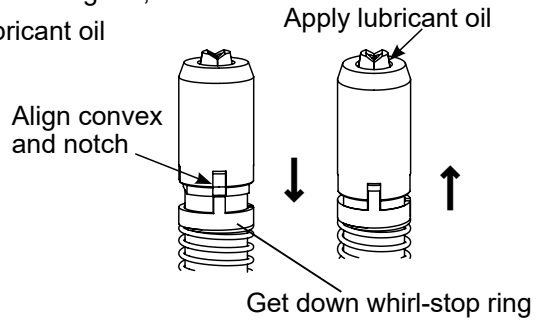

2

Cleaning the Spool section

If dust is accumulated at spool area, spool cannot move smoothly. Spool must be cleaned when spool moves slowly or improperly.

DISASSEMBLY

- 1** Stop air supply.
- 2** Remove spool cap A and B with a spanner.
- 3** Use stick such like plastic which does not create damage and take off the Spool from Spool Cap A side.

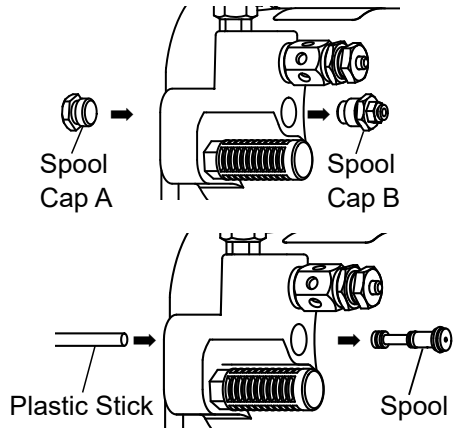

CLEANING

4 Clean up each part with a brush. In this case, make sure that the small hole of the spool is not plugged.

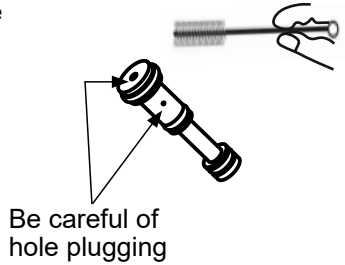

RE-ASSEMBLY

5 Assemble parts in the reverse procedure of disassembly. At assembly, apply lubricant oil on the O-ring of the spool.

3

Checking Hydraulic Oil

Generally, riveting is completed by only one switch lever operation. However, if hydraulic oil is decreased, multiple switch lever operations are needed. In this case, hydraulic oil must be checked.

点
検

- 1 Stop air supply.
- 2 Stand the booster, wind the oil tank cap counterclockwise, and remove it.

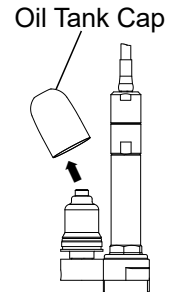

- 3 Check the condition of the internal tank by visual contact. If the internal tank are dented or inflated, the hydraulic oil might be insufficient or the air might got inside. Please contact your nearest distributor how to take out the air.

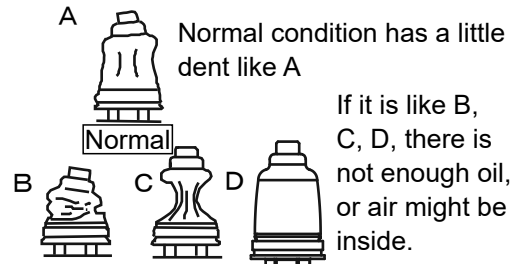

Oil shortage or air might got inside.

- 4 Remove the cap.

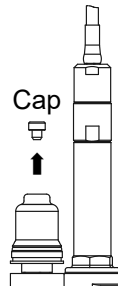

- 5 Fuel proper amount of oil. Fill up the oil by supporting the tank carefully to see if the oil does not overflow.

CAUTION

Make sure to use Lobtex's hydraulic oil. Other manufacturer's oil may affect the tool's performance negatively.

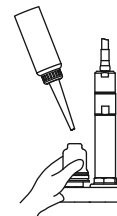

- 6 Press the tank lightly not to allow air to go into the tank and replace the cap and the oil tank cap.
- If the switch lever operation got required few times after performing jaw maintenance and supplying hydraulic oil, there are possibility that some air got inside. Please contact your nearest distributor how to take out the air.

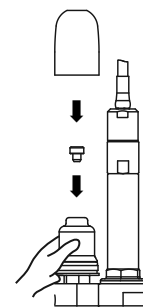

FILLING OIL

4

DISCONNECTING HYDRAULIC COUPLER

In some cases, disconnecting head area from booster area makes it easier to do maintenance work or refueling. In that case, disconnect hydraulic coupler as following procedure:

DISASSEMBLY

- 1** Stop air supply.
- 2** Remove the coupler bag by a spanner.
- 3** Pull out the male coupler.

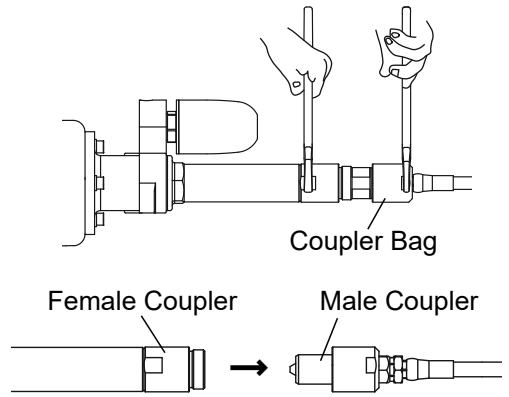

RE-ASSEMBLY

- 4** Stand the booster and pour the oil to the B-ring line of the male coupler.
- 5** Press-in the male coupler and wipe out the leaked oil.
- 6** Fasten the coupler bag with a spanner.

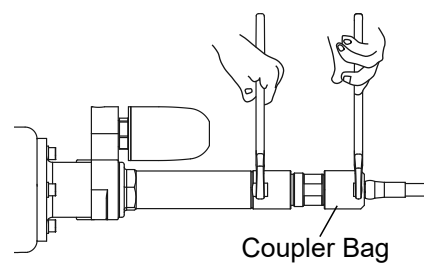
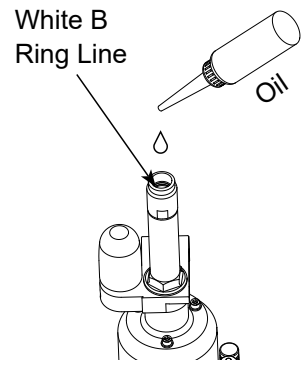

5

Cleaning the Nozzle Unit section

If dust is accumulated at nozzle unit, power of vacuuming rivet's mandrel weakens. If power of vacuuming mandrel is getting weak, check as following procedure:

DISASSEMBLY

1

Stop air supply.

2

Remove the safety cover and the chute hose.

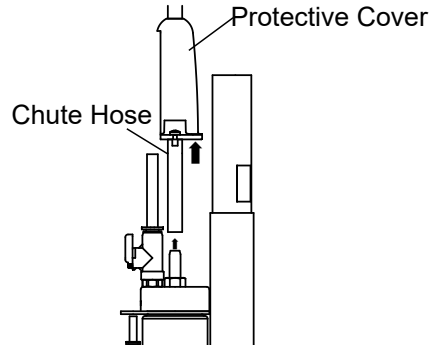

3

Remove the nozzle unit from the main unit by a spanner.

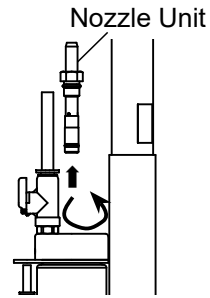

4

Disconnect the nozzle unit A from the nozzle unit B.

Important

They are connected a little tight. Therefore, disconnect them by pliers. Be careful not to hurt the O-ring attached with the nozzle A.

Nozzle Unit

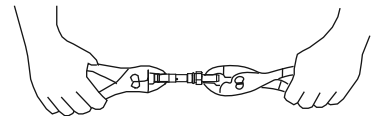
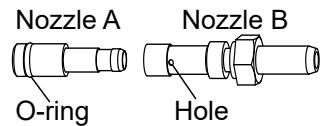

CLEANING

5

Clean carefully inside of the tube of the nozzle A and the nozzle B, and the small hole of the nozzle B.

RE-ASSEMBLY

6

Assemble parts in reverse procedure of disassembly.

● STORAGE

- This to in less dust, less humid and drafty place on solid floor.
- When not using the tool for a while please do the maintenance shown on “P.10 - P.14 CLEANING AND MAINTENANCE” and stow.
- To use the tool longer, we recommend you to request us overhaul service periodically. (Overhaul is not a free-of-charge service) Consult the store you purchased this tool or Lobtex local sales office about overhaul service and other maintenance service.

● ORDERING PARTS

Specify the model, part name, code number and the quantities of parts as shown below and place an order with the “LOBSTER” dealer where you purchased the tool.

Model	Part name	Code No.	Qty.
ARV-025M	Hard tool material Jaw, Medium	10281	1 set
ARV-025M	Frame Head	10105	1 set

* When parts are modified for improvement, the older parts are kept in stock for a period of five years.

PARTS TABLE

HEAD AREA

Head Unit is consisted of the following parts:

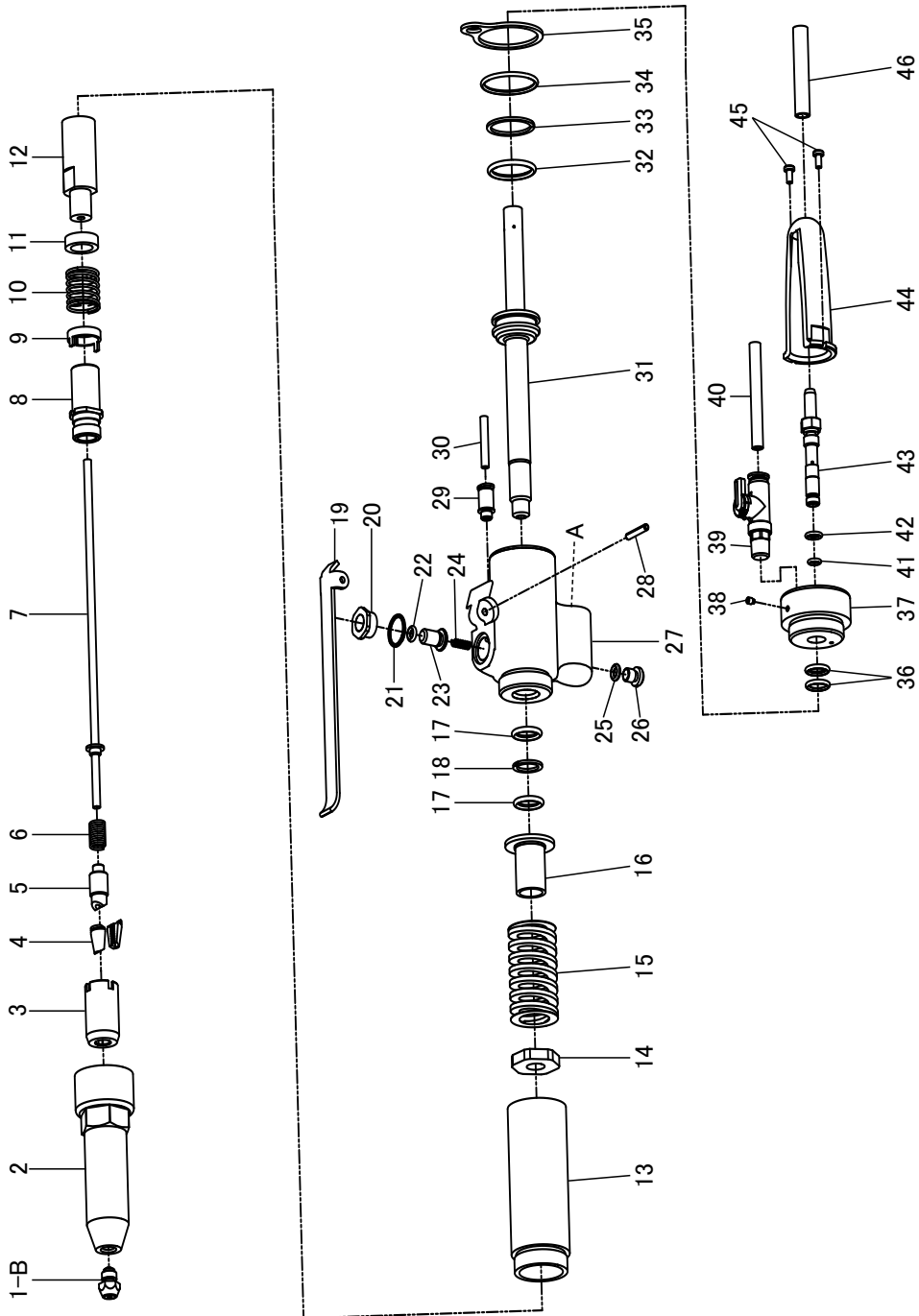

Index No.	Part name	Code No.	Material	Index No.	Part name	Code No.	Material
1-B	Nosepiece 3.2	10028	Steel	24	Spring	22031	Steel
2	Frame head	10105	Steel	25	O-ring P-5	12120	Rubber
3	Jaw case head	10280	Steel	26	Oil retaining screw	12135	Steel
4	Jaw (hard tool material, med)	10281	Steel	27	*Frame (U)	23733	①
5	Jaw pusher	10132	Steel	28	Spring pin 3×18	10145	Steel
6	Jaw pusher spring	10133	Steel	29	Straight joint	14848	②
7	Guide Pipe A (U)	24366	Brass	30	Air tube φ 4×2.6 m	23672	Plastic
8	Jaw case	10279	Steel	31	Oil piston	23731	Steel
9	Collar	10286	Steel	32	Urethane O-ring P-22	25443	Rubber
10	Collar spring	10287	Steel	33	B-ring P-22	10181	Plastic
11	Jaw case spacer B	23750	Aluminum	34	O-ring S-28	10221	Rubber
12	Jaw case spacer A	23752	Steel	35	Hanger	10106	Steel
13	Hand grip	23744	Aluminum	36	O-ring P-10	10274	Rubber
14	Jaw case lock nut	23748	Steel	37	Frame cap	24364	Aluminum
15	Returning spring	23747	Steel	38	Hexagon socket set Screw M3x4	17101	Steel
16	Stop ring	23745	Steel	39	Air Cock (Ball Valve)	24365	③
17	O-ring P-12	10128	Rubber	40	Air Tube φ 6×2.6 m	24368	Plastic
18	B-ring P-12	10129	Plastic	41	O-ring S-5	10276	Rubber
19	Switch lever	23742	Steel	42	O-ring S-6	10220	Rubber
20	Switch lock nut	23741	Brass	43	*Nozzle Unit	14324	④
21	O-ring S-10	10151	Rubber	44	Safety Cover	25463	Aluminum
22	O-ring P-4	10454	Rubber	45	+(Plus)Pan-head Screw M3×8	20860	Steel
23	Switch	23740	Plastic	46	Chute Hose	10381	Plastic

- ① Aluminum · Rubber · Plastic ② Brass · Rubber · Plastic
 ③ Brass · Rubber · Stainless · Plastic ④ Brass · Rubber
 ⑤ Brass · Stainless

*No.27 includes No.17X2 and No.18X1.

*No.43 includes No.41X1 piece and No.42X1.

ACCESSORIES

Index NO.	Part name	Code NO.	Material
1-A	Nosepiece 2.4	10027	Steel
1-C	Nosepiece 4.0	10029	Steel
1-D	Nosepiece 4.8	10030	Steel
201	Spanner A	10141	Steel
202	Spanner B	10142	Steel
203	Hydraulic Oil	10012	---
204	Guide Pipe B (U)	24367	⑤

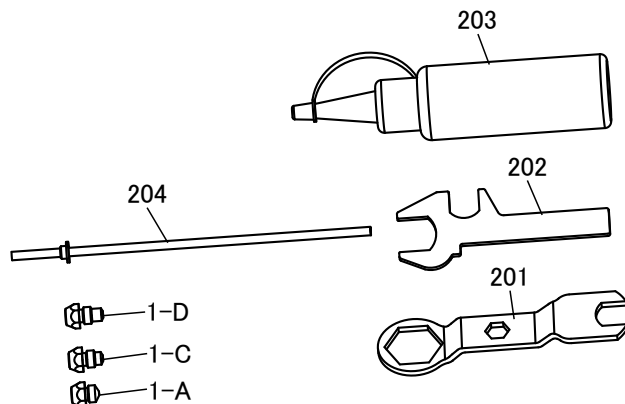

SWIVEL UNIT AND BOOSTER UNIT

Swivel unit and booster unit are consisted of the following parts:

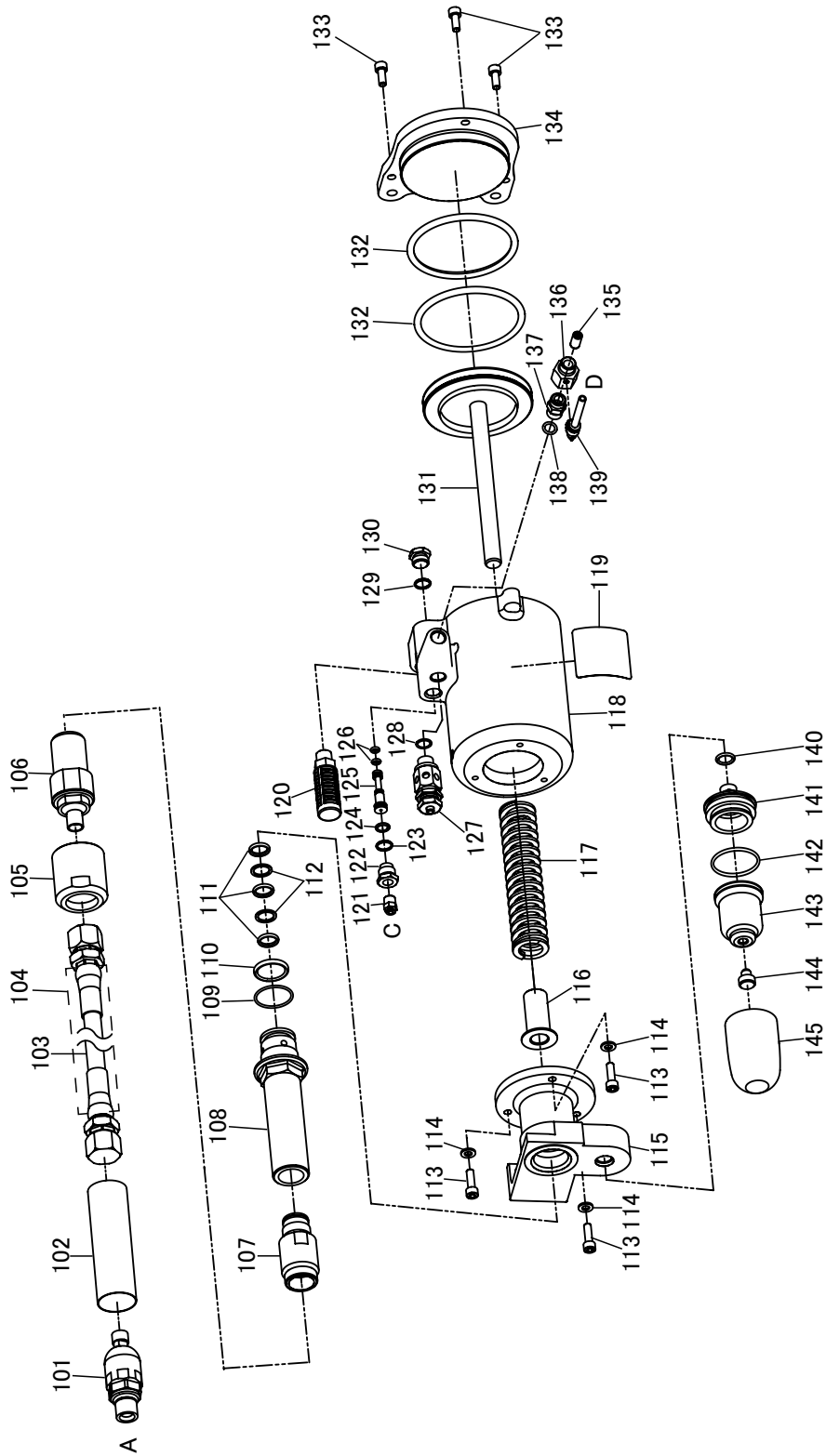

Index No.	Part name	Code No.	Material	Index No.	Part name	Code No.	Material
101	Swivel Joint (U)	23656	⑥	126	O-ring P-5	12120	Rubber
102	Rubber Bellow	28490	Rubber	127	*Safety Valve (U)	25467	④
103	Hydraulic Hose	23644	①	128	O-ring S-11	25590	Rubber
104	Protection Tube	23668	Plastic	129	O-ring S-12	23709	Rubber
105	Coupler Bag	23652	Steel	130	Spool Cap A	23688	Brass
106	Coupler Male Joint (U)	23645	⑥	131	*Air Piston (U)	67919	②
107	Coupler Female Joint (U)	23710	⑥	132	O-ring P-85	10452	Rubber
108	*Oil Cylinder (U)	23682	②	133	Hex socket bolt M6x15	23690	Steel
109	O-ring S-30	23685	Rubber	134	Air Cylinder Cap	23678	Aluminum
110	O-ring P-24	10207	Rubber	135	Fixing Screw	22030	Stainless
111	O-ring P-14	10434	Rubber	136	Branch Plug	22029	Steel
112	B-ring P-14	10435	Plastic	137	Nipple	14484	Brass
113	Hex socket bolt M5x10	25593	Steel	138	O-ring P-9	10219	Rubber
114	Plain Washer (M6)	24426	Steel	139	L-type Joint	22034	⑤
115	Oil Cylinder Joint	23700	Aluminum	140	O-ring P-12	10128	Rubber
116	Booster Spring Collar	67916	Plastic	141	Oil Tank Base	23693	Aluminum
117	Returning Spring	23691	Steel	142	O-ring G-30	12445	Rubber
118	Air Cylinder	23706	Aluminum	143	Oil Tank	15644	Rubber
119	Warning Label	61075	⑦	144	Cap	15819	Plastic
120	Silencer	23689	Plastic	145	Oil Tank Cap	15606	Aluminum
121	Straight Joint	10273	③	---	---	---	---
122	Spool Cap B	23708	Brass	---	---	---	---
123	O-ring S-12	23709	Rubber	---	---	---	---
124	O-ring P-8	10336	Rubber	---	---	---	---
125	Spool	23707	Brass	---	---	---	---

- ① Steel · Plastic ② Aluminum · Rubber · Plastic ③ Brass · Rubber · Stainless · Plastic
 ④ Brass · Rubber · Stainless ⑤ Brass · Rubber · Plastic ⑥ Rubber · Steel · Plastic
 ⑦ Paper · Plastic

*No.108 includes No.109X1, No.110X1, No.111X3, and No.112X2.

*No.127 includes No.128X1.

*No.131 includes No.132X1.

● TROUBLESHOOTING

If a problem occurs, check the followings.

If the problem persists after checking the items in the table below, contact your nearest "LOBSTER" dealer or contact Lobtex.

In making any inquiries about this product or requests for repair work, first check the troubleshooting items below and then make a note of the model number, the usage conditions and the trouble symptoms in as much detail as possible. If you can provide this kind of information, it may reduce the amount of time required for delivery or repairs to be completed.

Trouble	Cause	Countermeasure
Rivets cannot be inserted, of mandrels cannot be discharged after cut.	1 Nosepiece is wrongly used.	Use proper Nosepiece with the rivet size. (Refer to page 7.)
	2 Nosepiece or frame head is loosened.	Tighten them up completely.
	3 Jaw does not contact with jaw case head properly.	Clean up the taper area of jaw case head, and apply lubricant oil to back side of jaw. (Refer to page 10.)
	4 Size of guide pipe is improper, or guide pipe is missing.	Attach proper guide pipe with the rivet size.
Does not finish the rivet working by single stroke.	1 Rivet size is improper with the plate thickness.	Use proper rivet.
	2 Air pressure of compressor is improper.	Adjust air pressure. (Refer to page 8.)
	3 Jaw is worn.	Replace jaw with a new one. (Refer to page 10.)
	4 Jaw case head is not attached properly.	Wind and tighten jaw case head to the end return it to the position where convex and notch are aligned, then set up Collar. (Refer to page 11.)
	5 Piston stroke is not enough due to lack of hydraulic oil.	Refill hydraulic oil. (Oil piston stroke is 19mm). (Refer to page 12.)
Abnormal operation such that piston does not work or moves slowly.	1 Spool does not work properly.	Clean up spool. (Refer to page 11.)
	2 Spool does not work properly because silencer is clogged.	Replace silencer with a new one.
	3 Air piston does not work properly due to dirty inside of cylinder or lack of oil.	Please contact your distributor.
Power of vacuuming rivets is weak, or mandrels are not discharged.	1 The chute hose is full with mandrels.	Detach the tank unit and make it empty.
	2 Guide pipe of riveter is clogged with mandrels.	Detach the guide pipe and remove mandrels.
	3 Nozzle unit is dirty.	Clean up the nozzle unit. (Refer to page 14.)
	4 Chute hose is clogged with mandrels.	Detach the chute hose and remove mandrels.
	5 Chute holes is too long (Chute hose other than specified is used).	Use the specified chute hose.
	6 There is an obstacle at the end of chute hose.	Prepare enough space so that the end of the chute hose is not blocked by an obstacle. (Refer to page 7.)
	7 Air pressure is too low.	Adjust the air pressure to proper value. (Refer to page 8.)
	8 The vacuum air cock opens insufficiently.	Turn the air cock to OPEN side (counter clockwise) to the position it stops. (Refer to page 9.)

WARRANTY & SERVICE

LOBSTER[®] WARRANTS THAT GOODS COVERED BY THIS MANUAL WILL CONFORM TO APPLICABLE SPECIFICATIONS AND DRAWINGS AND THAT SUCH GOODS WILL BE MANUFACTURED AND INSPECTED ACCORDING TO GENERALLY ACCEPTED PRACTICES OF COMPANIES MANUFACTURING INDUSTRIAL TOOLS. THERE ARE NO WARRANTIES WHICH EXTEND BEYOND THE FOREGOING.

THE LIABILITY OF LOBSTER[®] ON PARTS FOUND TO BE DEFECTIVE IS LIMITED TO RE-WORK OR THE REPLACEMENT OF SUCH GOODS AND IN NO CASE TO EXCEED THE INVOICE VALUE OF THE SAID GOODS. UNDER NO CIRCUMSTANCES WILL LOBSTER[®] BE LIABLE FOR DAMAGES OR COSTS INCURRED BY THE BUYER OR SUBSEQUENT USER IN REPAIRING OR REPLACING DEFECTIVE GOODS.

ROUTINE MAINTENANCE AND REPAIR OF LOBSTER[®] RIVET TOOLS CAN BE PERFORMED BY AN AVERAGE MECHANIC. HOWEVER, IF YOU HAVE A LOBSTER[®] RIVET TOOL THAT IS IN NEED OF MAJOR REPAIR WE RECOMMEND THAT IT BE SENT DIRECTLY TO US POSTAGE PAID FOR SERVICE AT A REASONABLE CHARGES.

MANUFACTURER

LOBTEX CO.,LTD.

OSAKA,JAPAN

There are revision in parts table and partial change in specification.

O-ring P-10 has been added to the inside of the frame head of ARV025M.

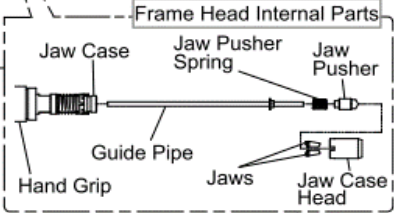
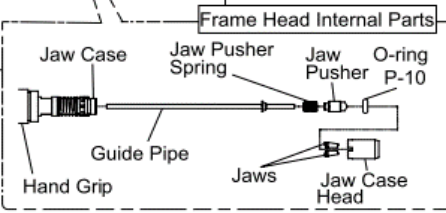
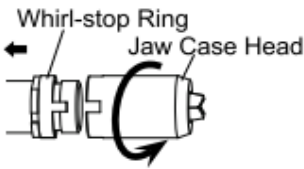
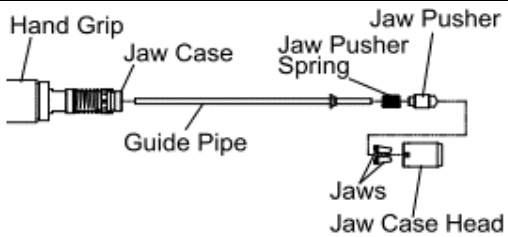
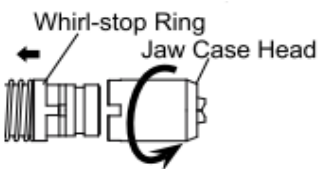
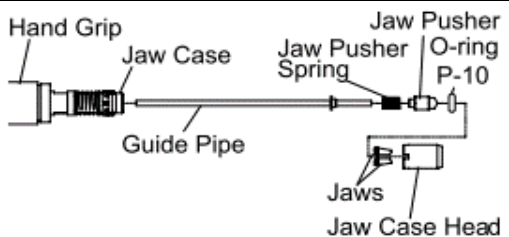
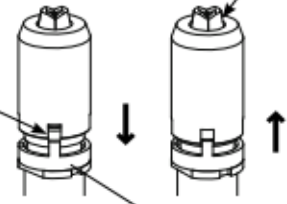
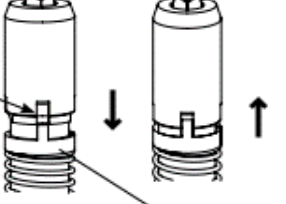
	Previous	Current
P.5		
P.9	<p>4 Turn the vacuum air cock to clockwise to activate the vacuum device. The vacuum device is activated. You can hear the vacuum noise.</p>	<p>4 Turn the vacuum air cock to counter clockwise to activate the vacuum device. The vacuum device is activated. You can hear the vacuum noise.</p>
P.10	 	 
P.11	<p>When they are aligned, apply lubricant oil.</p>  <p>Align convex and notch</p> <p>Apply lubricant oil</p> <p>Get down whirl-stop ring</p>	<p>When they are aligned, apply lubricant oil.</p>  <p>Align convex and notch</p> <p>Apply lubricant oil</p> <p>Get down whirl-stop ring</p>
P.16	